



**Whiteriver**

composite for living

*New Collection*

**COMPOSITE DECKING & CLADDING**





# Why Composite Decking

**Composite Decking** is for the home-owner who wants a decking product with a natural look, uniform colouration and will not need any annual oil treatment like conventional wood decks. Composite Decking has a long lifespan, which saves time and money, now and in the future.

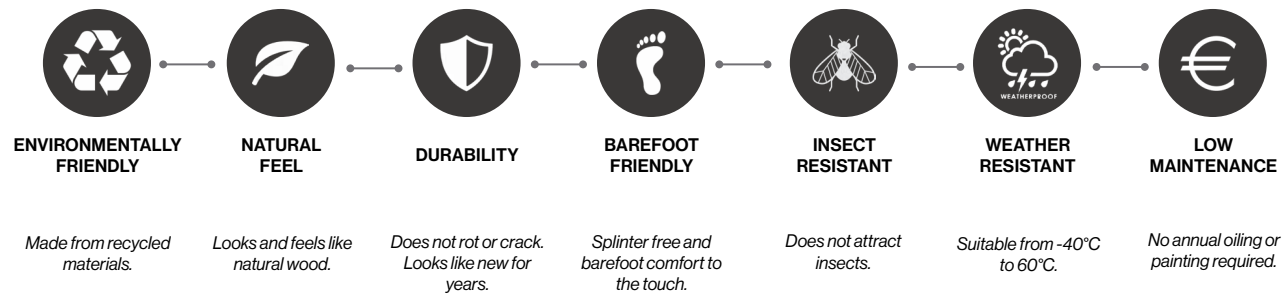

## What is Composite Decking



Our Composite Decking is made using 60% recycled wood, 30% recycled high density polyethylene and 10% additives and pigments. The unique mixture creates a revolutionary composite of improved, user friendly material that outperforms traditional wood and plastic decks.

Strong and durable, Our Composite Decking looks and feels just like natural wood. The unique formula provides long lasting composite timber decking that is environmentally friendly, easy to install and requires less maintenance compared with traditional timber and comes with a 10 year (Portland) and 25 year (UltraShield) limited warranty.

Our Composite Decking was developed to meet the exceptionally high standard required for outdoor living today. Our decking is ideal for the construction of commercial and domestic decks, marinas, board walks and swimming pool surrounds as well as many other uses.

Installation is simple using a handy clip system that creates a smooth even look to the deck. This system means that you do not have to use unsightly screws or nails and the board spacing is already worked out.

# CONTENTS

<b>Portland</b>	06
Montana Woodgrain	09
Montana	11
Arizona	17
Nevada Solid	19
Portland Components	22
<b>UltraShield</b>	26
Eco	31
Naturale	33
Wide Board	47
UltraShield Components	54
Aluminium Railing	57
Pedestals	60
Deck Preparation	66
Do's & Don'ts	68
Installation Guide	72
<b>Cladding</b>	76
Contemporary	79
Traditional	83
F.A.Q.s	90
Deck Maintenance	91

# Ecological

## Composite Decking & The Environment

At Whiteriver, we believe that sustainability using recycled materials is essential for the future of our environment. When you buy our composite decking, you can feel confident that your purchase has been kind to the environment.

**Our decking and cladding help the environment by using recycled material, both the wood fibres and plastic in our decking come from recycled material. To help understand the benefits of this recycling, each length of composite decking contains the equivalent of over 50 recycled plastic bottles. The product also comes with a comprehensive warranty, supporting its long life expectancy which further enhances its friendliness to the environment. Our product outperforms the competition with unrivalled quality and appearance, making your outdoor space the envy of all who have the pleasure of using it.**

The growing public concern for environmental sustainability is at the heart of the manufacturing process. Total vertical integration of the manufacturing process using the recycled materials allows for complete control providing for consistent quality and finish.

### **Our composite decking is made from:**

- 60% wood fibre, which is sourced as recyclable waste from other industries.
- 30% HDPE (high density polyethylene) which is from recycled plastic.
- 10% additives / pigments.









**Whiteriver**

composite for living

# INTRODUCING PORTLAND

## Decking Calculator Estimator (No. of boards required)

Product	10m <sup>2</sup>	12m <sup>2</sup>	14m <sup>2</sup>	16m <sup>2</sup>	18m <sup>2</sup>	20m <sup>2</sup>	22m <sup>2</sup>	24m <sup>2</sup>	26m <sup>2</sup>	28m <sup>2</sup>	30m <sup>2</sup>	32m <sup>2</sup>	34m <sup>2</sup>	36m <sup>2</sup>	38m <sup>2</sup>	40m <sup>2</sup>	42m <sup>2</sup>	44m <sup>2</sup>	46m <sup>2</sup>	48m <sup>2</sup>	50m <sup>2</sup>
Montana / Montana Woodgrain	20	24	28	32	35	39	43	47	51	55	59	63	67	71	75	79	83	87	91	95	99
Nevada	19	23	27	31	35	38	42	46	50	54	58	61	65	69	73	77	81	84	88	92	96
Arizona	18	22	26	29	33	37	40	44	48	52	55	59	63	66	70	74	77	81	84	89	92

*Above excludes waste factor - 20 clips required per square metre.*

# PORTLAND RANGE

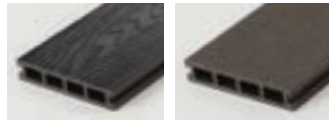

## NEW MONTANA WOOD GRAIN

See page 9

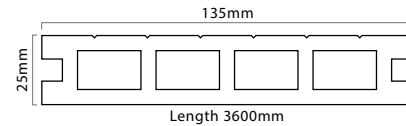

Board Dimensions: **135x25x3600mm**  
Board Coverage: **0.508m<sup>2</sup> (1m<sup>2</sup> = 1.97 boards)**



## MONTANA

See page 11

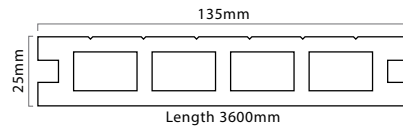

Board Dimensions: **135x25x3600mm**  
Board Coverage: **0.508m<sup>2</sup> (1m<sup>2</sup> = 1.97 boards)**

*\*Montana Bfl-S1 fire rated option also available see page 15*

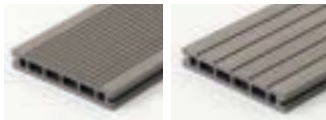

## ARIZONA

See page 17

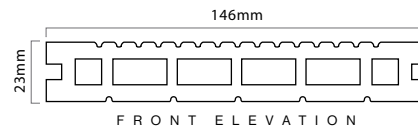

Board Dimensions: **146x23x3600mm**  
Board Coverage: **0.544m<sup>2</sup> (1m<sup>2</sup> = 1.84 boards)**

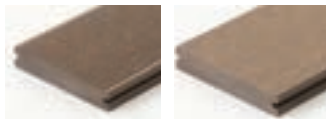

## NEVADA

See page 19

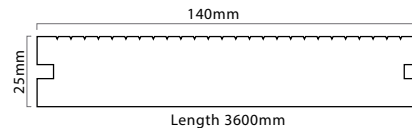

Board Dimensions: **140x25x3600mm**  
Board Coverage: **0.522m<sup>2</sup> (1m<sup>2</sup> = 1.92 boards)**

PORTLAND	RAL No
Montana Soft Grey	7037
Montana Charcoal	7022
Montana Anthrazit	8014
Montana Fired Earth	8025
Nevada Soft Grey	7037
Nevada Anthrazit	8014
Arizona Soft Grey	7037

*RAL Colour match is not an exact match due to texture and colour variation in the boards.*

For technical data information, please consult our website - [www.wrg.ie](http://www.wrg.ie)



*Acc. to Whiteriver terms - see [wrg.ie](http://wrg.ie) for full details.*

Our premium quality composite decking Portland range includes Montana, Montana Woodgrain, Montana Fire Rated board, Nevada, and Arizona, each designed to cater to your unique decking needs. This range is built to offer the perfect combination of durability, longevity, and style, ensuring your outdoor space looks stunning for years to come. Whether you are looking for a natural wood-like appearance or a bold statement, our Portland Range has got you covered.





SMOOTH

NEW  
WOODGRAIN



PORTLAND MONTANA  
ANTHRAZIT

↩ Reversible Boards ↪

SMOOTH SIDE

PORTLAND MONTANA ANTHRAZIT



# NEW Woodgrain PORTLAND MONTANA

We have added a new dimension to our popular Montana composite deck board with this new Woodgrain effect which has a reversible board underside. This board has all the familiar attributes and carries over the same specifications of our current Montana board while creating an alternative surface finish.

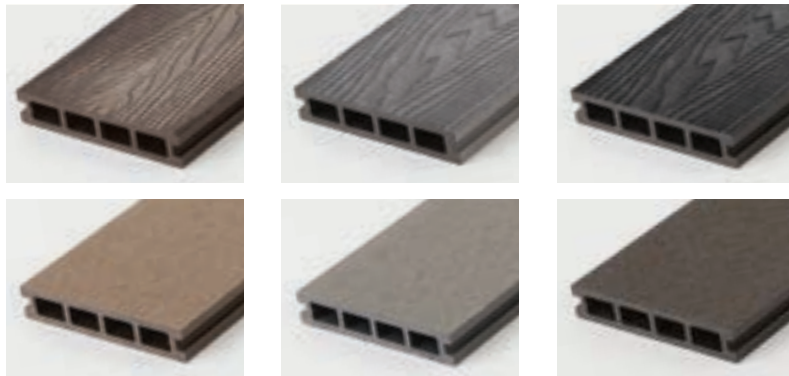

↻ Reversible Boards ↻

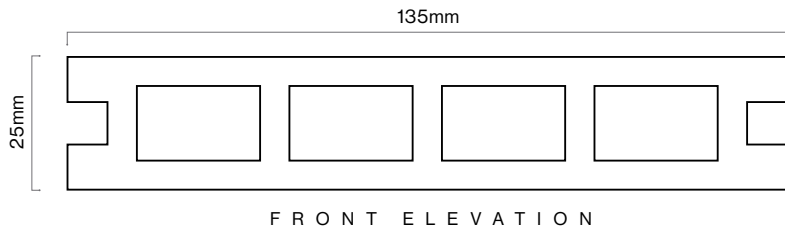

Board Dimensions: 135x25x3600mm Board Coverage: 0.508m<sup>2</sup> (1m<sup>2</sup> = 1.97 boards)

Whiteriver MONTANA

PORTLAND  
10 YEAR LIMITED WARRANTY

Acc. to Whiteriver terms - see wrgie for full details



Charcoal Grooved - Side 1    Soft Grey Grooved - Side 1    Anthrazit Grooved - Side 1



Charcoal Smooth - Side 2    Soft Grey Smooth - Side 2    Anthrazit Smooth - Side 2

- ✓ Hidden Fixing System
- ✓ Finishing Trims Available
- ✓ Matching Posts & Railings  
\*Excluding Charcoal





**PORTLAND**  
**10** YEAR LIMITED WARRANTY

Acc. to Whiteriver terms - see wrgie for full details

Whiteriver MONTANA

# PORTLAND MONTANA

Our Montana composite decking takes its name from the American “Big Sky Country” of the same name. It comes with a hollow construction and with the option of a reversible smooth or grooved surface. Our most popular design is available in four colours and comes with matching railings and accessories.\*

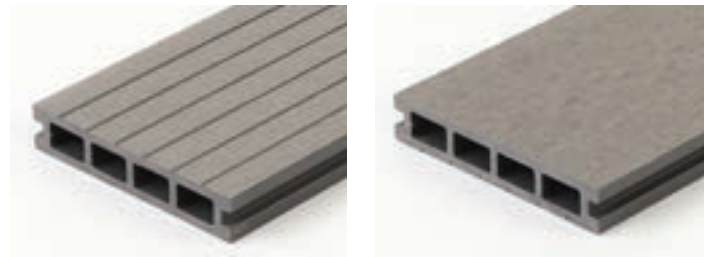

↻ Reversible Boards ↻

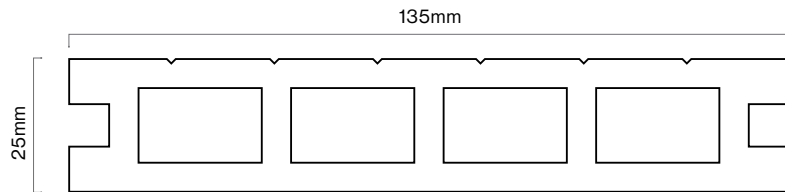

FRONT ELEVATION

Board Dimensions: **135x25x3600mm** Board Coverage: **0.508m<sup>2</sup> (1m<sup>2</sup> = 1.97 boards)**



Charcoal Grooved - Side 1    Soft Grey Grooved - Side 1    Anthrazit Grooved - Side 1    Fired Earth Grooved - Side 1



Charcoal Smooth - Side 2    Soft Grey Smooth - Side 2    Anthrazit Smooth - Side 2    Fired Earth Smooth - Side 2

- ✓ Hidden Fixing System
- ✓ Finishing Trims Available
- ✓ Matching Posts & Railings  
\*Excluding Charcoal

**While stocks last**

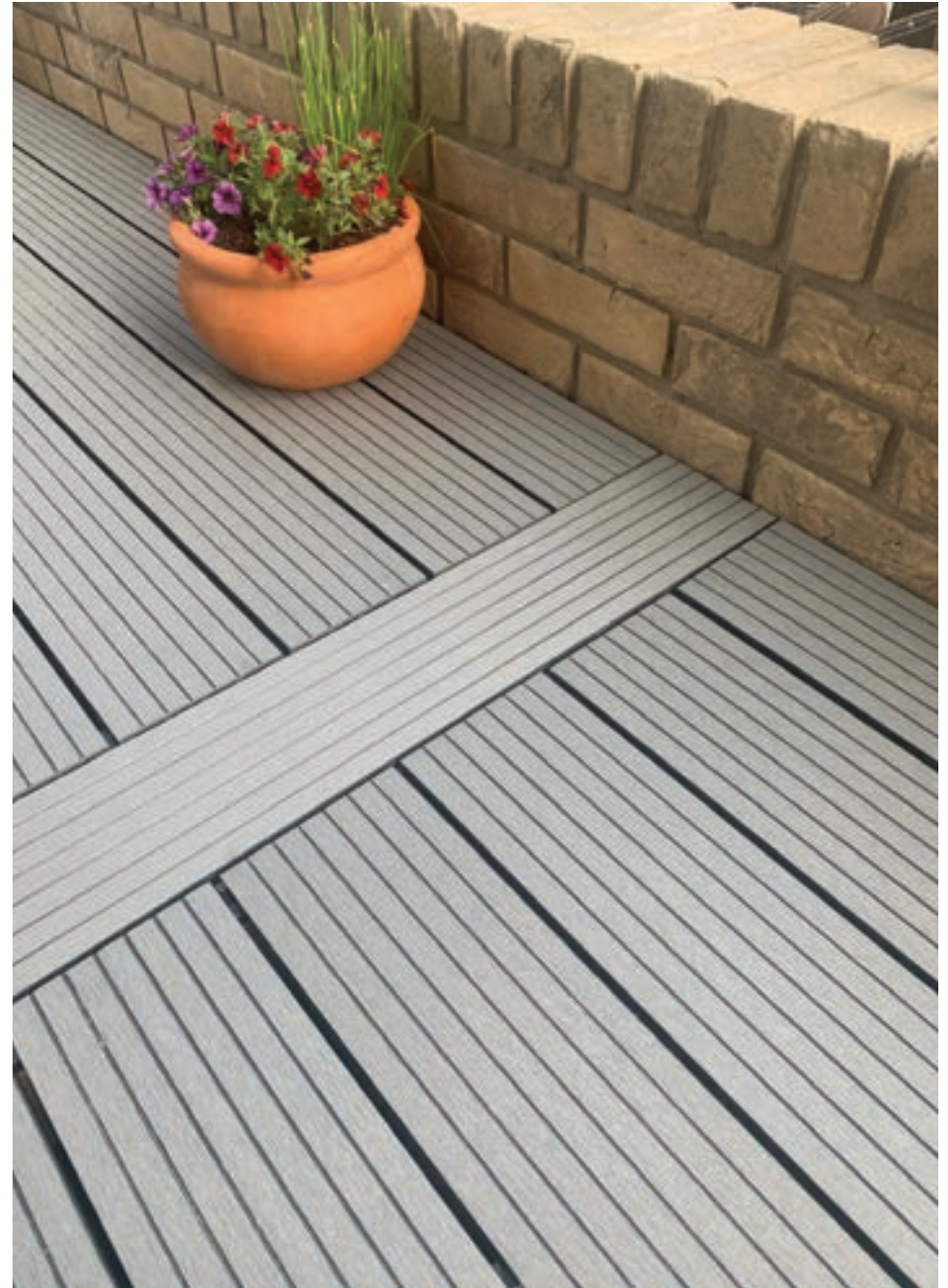











**PORTLAND**  
**10** YEAR LIMITED WARRANTY

Acc. to Whiteriver terms - see wrgie for full details

# PORTLAND MONTANA

## *FIRE RATED - BFL-S1*

Our Fired Rated Portland Montana achieves a fire rating of BFL-S1 (EN 13501-1). This rating is higher than standard composite decking and provides better performance where there is a requirement to achieve a fire rating of BFL-S1. This rating may be requested for public areas. Our Portland decking is also CE Certified for fire.

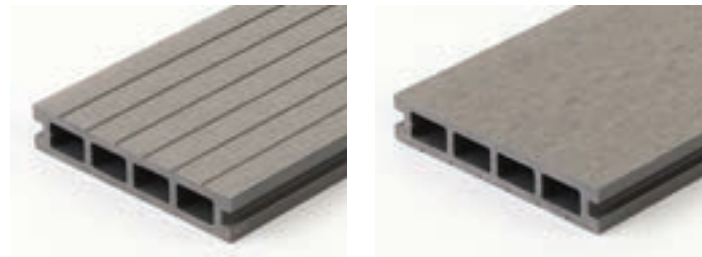

↔ Reversible Boards ↔

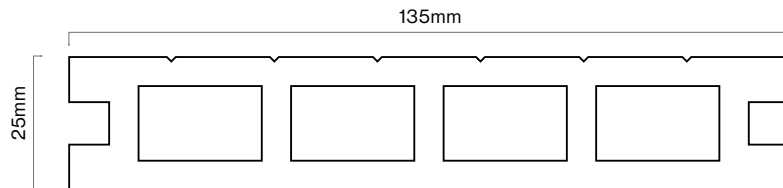

FRONT ELEVATION

Board Dimensions: **135x25x3600mm** Board Coverage: **0.508m<sup>2</sup> (1m<sup>2</sup> = 1.97 boards)**

Whiteriver MONTANA



Soft Grey Grooved - Side 1



Anthrazit Grooved - Side 1

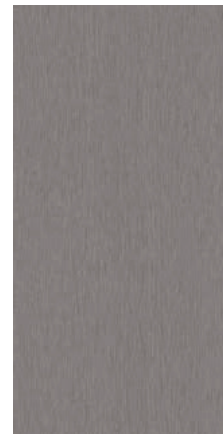

Soft Grey Smooth - Side 2

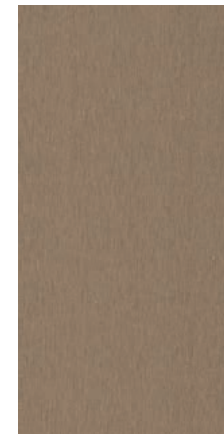

Anthrazit Smooth - Side 2



Hidden Fixing System



Fire Rated BFL S1





# PORTLAND ARIZONA

Our Arizona decking inherits its name from the popular American State. Home of the Grand Canyon, a mile deep chasm carved by the Colorado River. This reversible board is both beautiful and resilient and allows you to choose between a ribbed or grooved surface making it the quintessential deck of choice for the connoisseur.

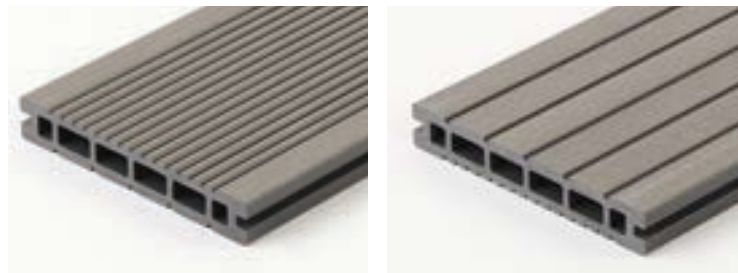

↩ Reversible Board ↪

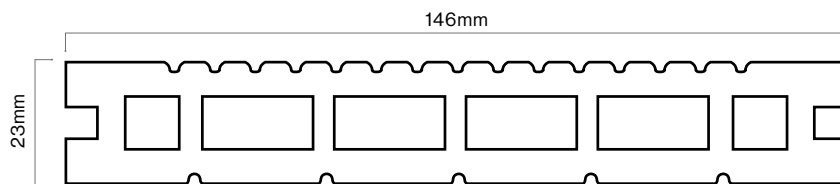

F R O N T E L E V A T I O N

Board Dimensions: **146x23x3600mm** Board Coverage: **0.544m<sup>2</sup>** (1m<sup>2</sup> = 1.84 boards)



Soft Grey Grooved - Side 1

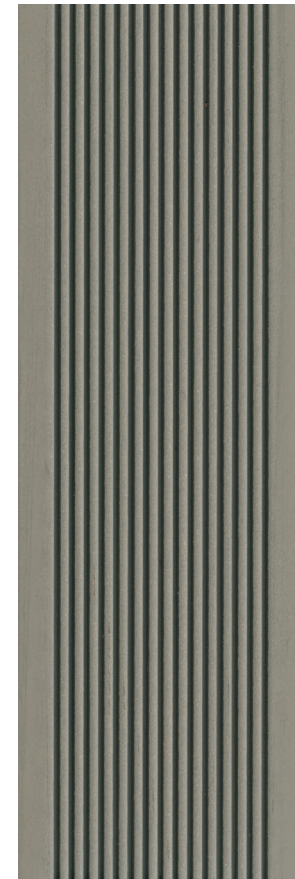

Soft Grey Ribbed - Side 2



Hidden Fixing System



Finishing Trims Available  
\*excludes stair treads



Matching Posts & Railings





# PORTLAND NEVADA SOLID

Known as the “Battle Born State”, Nevada Composite Decking deservedly gets its name from this beautiful, awe inspiring and diverse State. Tough and durable enough to withstand all types of harsh weather. Alluring texture with a contrasting grooved side or choice of a smooth sleek side.

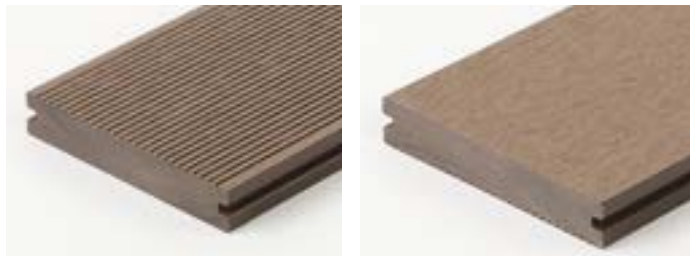

↻ Reversible Boards ↻

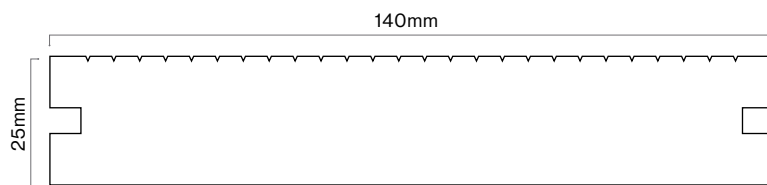

F R O N T E L E V A T I O N

Board Dimensions: **140x25x3600mm** Board Coverage: **0.522m<sup>2</sup>** (1m<sup>2</sup> = 1.92 boards)

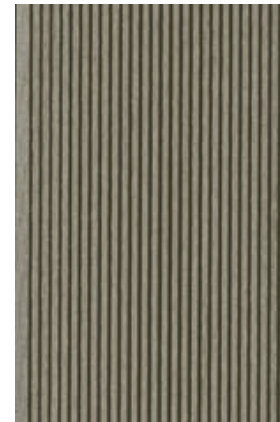

Soft Grey Ribbed - Side 1



Anthrazit Ribbed - Side 1

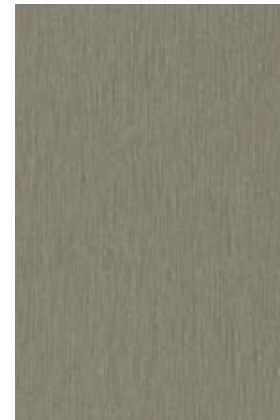

Soft Grey Smooth - Side 2



Anthrazit Smooth - Side 2



Hidden Fixing System

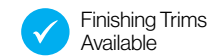

Finishing Trims Available

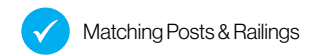

Matching Posts & Railings

## Finishing touches

Deck fascia boards provide the perfect finishing touch and create a smooth, streamlined look for your composite wood deck. Fascia boards create a band of wood bordering the deck just below the surface line to hide the joists underneath and elevate the overall appearance of the deck.

Naturally, for the most seamless, aesthetically pleasing look, as well as for durability and low-maintenance, you will want your fascia boards to be made of the same composite wood material as the rest of your deck, which is why Whiteriver is happy to offer fascia boards among our line of quality products.



NEVADA ANTHRAZIT WITH MATCHING POSTS & RAILS 140 X 25 X 3600MM

*Note: Portland hand rail is only suitable for installation to a maximum of 600mm above ground level.*







MONTANA SOFT GREY WITH MATCHING STAIR TREAD 135 X 25 X 3600MM

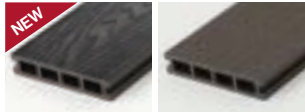

MONTANA SOFT GREY WITH MATCHING STAIR TREAD 135 X 25 X 3600MM

## PORTLAND DECK BOARDS

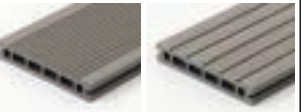
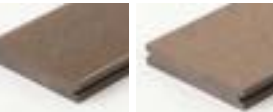
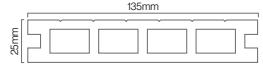
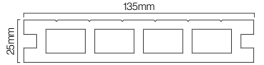
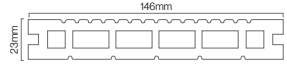
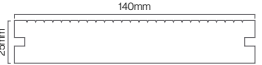
Montana Woodgrain	Montana	Arizona	Nevada
			
See page 09 <i>*Montana fire rated option also available see page 15</i>	See page 11	See page 17	See page 19
			
135 x 25 x 3600mm	135 x 25 x 3600mm	146 x 23 x 3600mm	140 x 25 x 3600mm

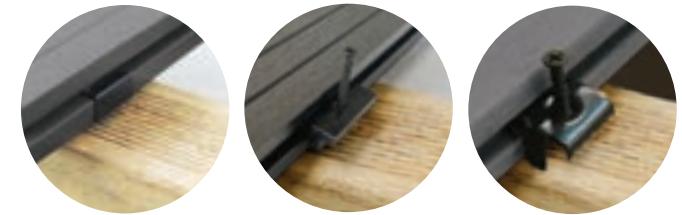

START/END CLIP

CLIP & SCREW

LOCKING CLIP





One locking clip to be installed at the centre point of each board to control even expansion and contraction along the length of the board. The locking clip has teeth on one side to catch the board.

## JOIST OPTIONS

Composite Joist	Aluminium Joist	Aluminium Double Joist	Joist Support	Joist Corner Bracket	Joist Joining Bracket
Generally for use on balconies where structural height is not possible. Ventilation and drainage need to be carefully considered for balcony installations. This joist is not load bearing. <b>"MUST BE PREDRILLED"</b>	Lightweight, strong and durable. Provides long lasting alternative to wooden joist.	This joist provides support and drainage channel where two board ends meet.	Stainless steel support for aluminium joists.	Stainless steel bracket for reinforcing corner joints on aluminium joist.  <i>Pack of 4 with Tek screws</i>	Stainless steel bracket for joining aluminium joists.  <i>Pack of 4 with Tek screws</i>
					
			Stainless Steel 362mm for 400mm centres with 38mm joist		
40 x 25 x 3000mm	38 x 38 x 3000mm	75 x 38 x 3000mm	362mm	50 x 50mm	100 x 25mm



## FIXING COMPONENTS

Installation Kit Timber Joist	Start/End Clip Timber Joist	Installation Kit Steel & Aluminium Joist	Start/End Clip Steel & Aluminium Joist
Secret fixings for securing boards to joists.	For securing first and last rows.	Contains self tapping screws.	Contains self tapping screws.
			
Includes 50 Clips & Screws and 8 Locking Clips (Covers 2.5m <sup>2</sup> )	25 per pack for first & last row	Includes 50 Clips & Screws and 8 Locking Clips (Covers 2.5m <sup>2</sup> )	25 per pack for first & last row

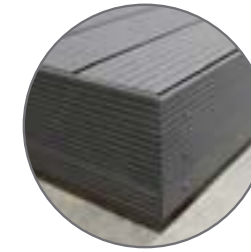

FASCIA BOARD

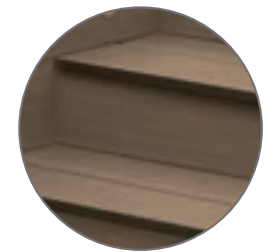

STAIR TREAD









INSTALLATION KIT

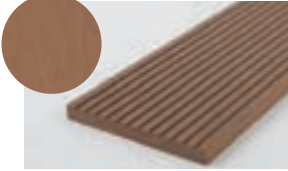

STAIR TREAD

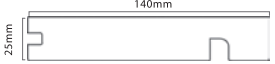
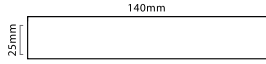
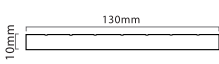

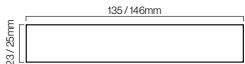





## PORTLAND TRIM OPTIONS

Stair Tread	Fascia Solid Plank	Fascia Solid Plank	Corner Wrap	End Pieces
Smooth Finish *Suitable for Montana & Nevada profiles only. Available in Soft Grey, Anthrazit, Fired Earth and Charcoal.	Available in Soft Grey, Anthrazit, Fired Earth and Charcoal.	Available in Fired Earth, Anthrazit, Soft Grey and Charcoal.	Available in Soft Grey, Anthrazit, Fired Earth and Charcoal.	Montana & Arizona
Professional finishing edge board with concealed fixing ideal for steps and finishing deck perimeter.	Smooth board for a simple clean finish to hide structural framework.	Smooth on one side and ribbed on the other for a simple clean finish to hide structural framework.	Finishing trim for corners and edges - we do not recommend these to be use for step edges. Corner wrap should be predrilled and fixed to the substructure - not the decking.	Used to blank off exposed board ends. Secure with outdoor silicone.
				
				
140 x 25 x 3600mm	140 x 25 x 3600mm	130 x 10 x 3600mm	40 x 40 x 3600mm	135 x 25mm (Montana) 146 x 23mm (Arizona)



**Note: It is very important to provide ventilation to enter the underside of your deck when finishing off side trims.**

## PORTLAND RAIL COMPONENTS

Available in Soft Grey, Anthrazit & Fired Earth.

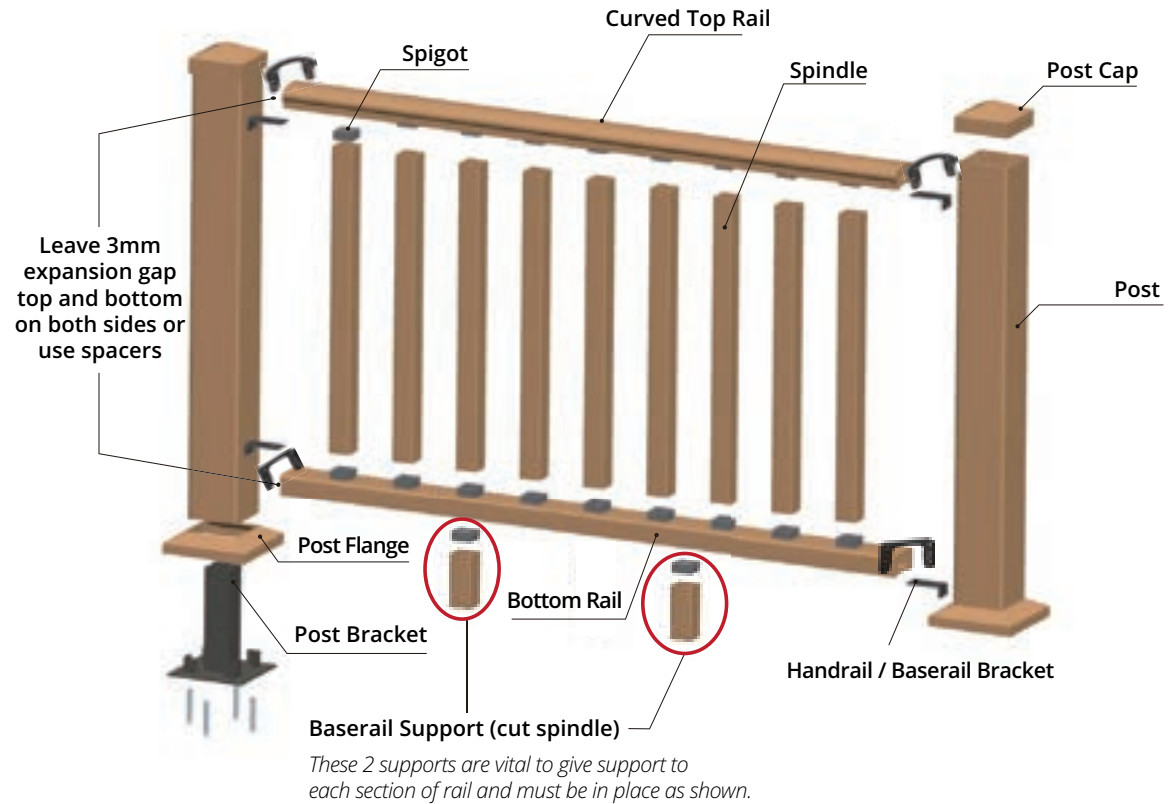
<p>CURVED HANDRAIL Curved Profile 100 x 50 x 1800mm</p>	
<p>RECTANGULAR BASERAIL / HANDRAIL Square Profile 90 x 45 x 1800mm Can also be used as contemporary handrail.</p>	
<p>SPINDLE Including Spigot &amp; Screws 50 x 50 x 900mm</p>	
<p>HANDRAIL / BASERAIL BRACKET 10 Per Pack Secures rails to posts.</p>	
<p>SQUARE POST CAP</p>	
<p>POST 120 x 120 x 1200/2400mm</p>	
<p>POST FLANGE Hides Post Bracket</p>	
<p>POST SUPPORT BRACKET Must be fixed to substructure (Screws for fixing to sub-construction not included)</p>	



<p>CURVED HANDRAIL Spacers supplied <b>free of charge</b> with handrail</p>	
<p>SQUARE HANDRAIL / BASERAIL Spacers supplied <b>free of charge</b> with handrail Allows for natural expansion &amp; contraction</p>	



## POST & RAILINGS INSTALLATION

**NOTE: IT IS IMPORTANT THAT COMPOSITE MATERIAL IS PRE-DRILLED PRIOR TO FIXING SCREWS INTO IT.**

### Step 1

As the diagram 2.1 below shows, firstly use expansion bolts to fix the Post Bracket in the right position of measured posts on the concrete ground or in case of timber joists, use coach screws suitable for outdoor use.

**THE POST BRACKET SHOULD BE FIXED TO THE SUB-CONSTRUCTION, NOT THE DECKING.**

We recommend that the spacing between two posts should be not more than 1800mm; this distance is based on the specific spacing between the spindles.

The standard spacing between spindles is 100mm. Insert the posts into the Post Bracket, then using fixing screws, fix the posts through the holes of the angle iron on the Post Bracket.

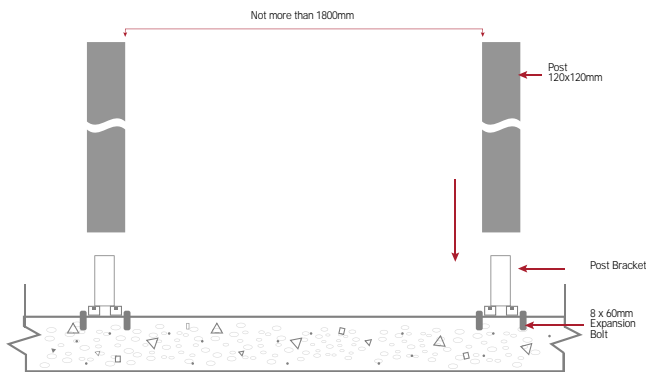

DIAGRAM 2.1

### Step 2

After fixing the posts, insert the post flange to the bottom of the posts; then mark the position for the top and bottom handrail on all posts. Fix the handrail bracket on the marked position on the post, just as diagram 2.2 below shows. It is important to leave 3mm expansion or use spacers where rail meets the post. We recommend that the spacing between two posts should be more than 1800mm.

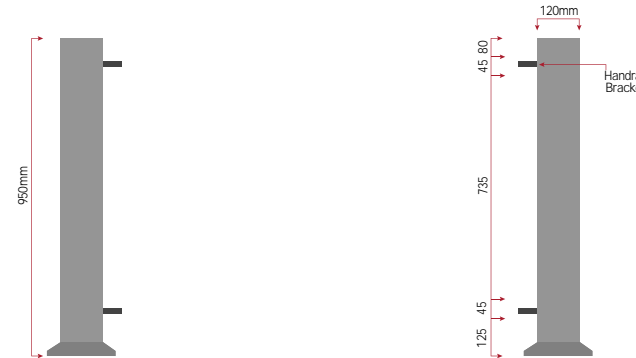
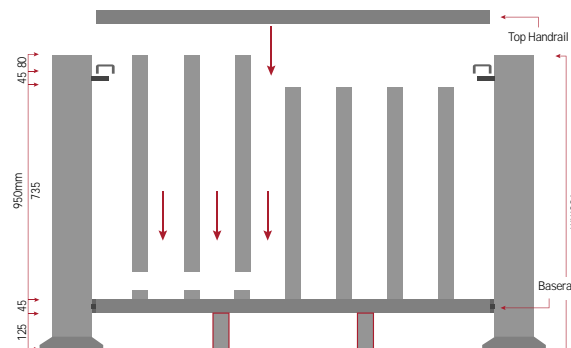

DIAGRAM 2.2

### Step 3

As diagram 2.3 below shows: fix the spindle spigot on both the top and bottom handrail - the fixing spacing is based on the standard spindle spacing of 100mm. Install and fix the top and bottom handrail to the handrail bracket - base rail spacers should be interested between post and rail to allow for natural expansion & contraction. Use external grade silicone adhesive in the spigot to fix securely and avoid any spindle movement.



### Step 4

Please install a minimum of 2 pieces of spindles below the bottom baserail as seen in the installation of spindles in diagram 2.4. These pieces must be spaced evenly to support the overall handrail section and avoid warping. This is very important.

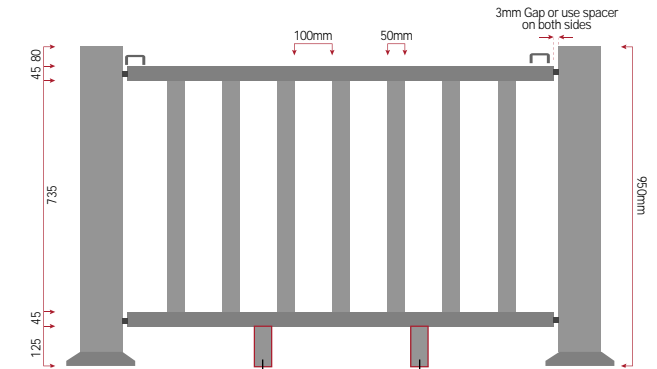
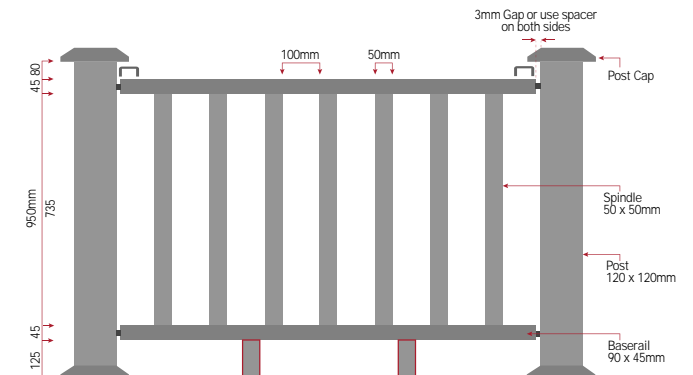

DIAGRAM 2.4

*These supports are vital to the structure of each section.*

### Step 5

Install the post cap on top of the posts. This is to prevent water accumulating within. Now you are finished the installation of the post and handrail system. Please consult the finished drawing of post and handrail system as shown in diagram 2.5 below.



*Note: Portland hand rail is only suitable for installation to a maximum of 600mm above ground level.*



**NewTechWood**

INTRODUCING

**UltraShield<sup>®</sup>**

**Decking Calculator Estimator (No. of boards required)**

Product	10m <sup>2</sup>	12m <sup>2</sup>	14m <sup>2</sup>	16m <sup>2</sup>	18m <sup>2</sup>	20m <sup>2</sup>	22m <sup>2</sup>	24m <sup>2</sup>	26m <sup>2</sup>	28m <sup>2</sup>	30m <sup>2</sup>	32m <sup>2</sup>	34m <sup>2</sup>	36m <sup>2</sup>	38m <sup>2</sup>	40m <sup>2</sup>	42m <sup>2</sup>	44m <sup>2</sup>	46m <sup>2</sup>	48m <sup>2</sup>	50m <sup>2</sup>
UltraShield Eco	19	23	27	31	35	38	42	46	50	54	58	61	65	69	73	77	81	84	88	92	96
UltraShield Naturale	20	23	27	31	35	39	43	47	51	55	59	62	66	70	74	78	82	85	90	94	98
UltraShield Wide Board	13	16	18	21	23	26	28	31	34	36	39	41	44	47	49	52	54	57	59	62	65



# UltraShield® Naturale™

## A true game changer in composite decking.

In 2010, our manufacturing partners began a project to design and formulate the most durable and attractive composite deck board in the industry.

A few years of engineering and countless hours of field-testing has yielded a product of unmatched performance and beauty. UltraShield combines the proven strength of high density polyethylene plastic and wood fibre with an outer shell of polymer that completely encapsulates the board in an impermeable layer of protection that provides scratch, stain and fade resistance.

### WHY “CAPPING”?

Making the board capped 360 degrees gives the board maximum protection against: mould/mildew, stains, fading, cracking, cupping and swelling.

Capping 360 degrees provides complete protection all around the board and protects it from UV, water, insects and any other mould/mildew from attacking the core.

For technical data information, please consult our website - [www.wrg.ie](http://www.wrg.ie)



According to Whiteriver terms See [wrg.ie](http://wrg.ie) for full details.

A few **good** reasons to choose  
**Newtechwood UltraShield**



**NewTechWood**

### 1. CO-EXTRUDED CAP

UltraShield is a capped composite, which means it has an advanced premium shield encasing ALL four sides around its inner core. The shield and core are extruded together under a very high temperature mould simultaneously, so there are no adhesives or chemicals that are harmful to the environment.

### 2. COMPOSITE CORE

The core is made from carefully selected recycled material and highly dense recycled hardwood and softwood fibre that allow for greater strength and durability and best of all it's 100% recyclable.

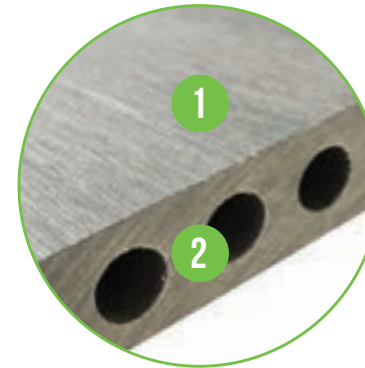

**360° CAPPED**  
protective polymer layer



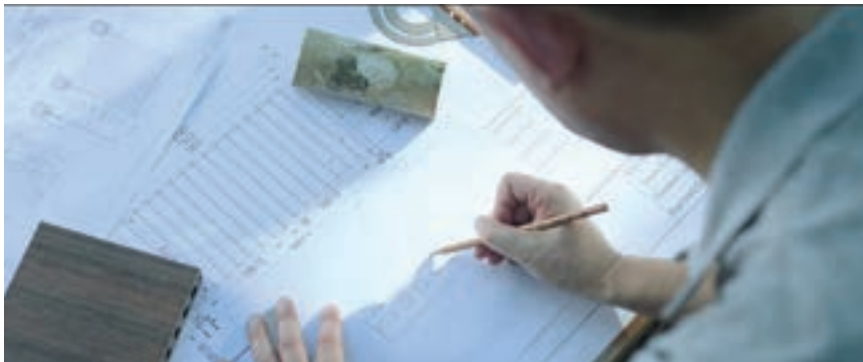
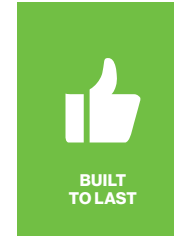
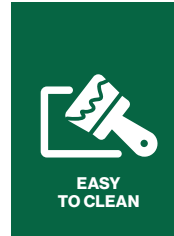
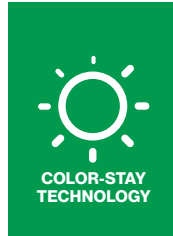

## From Subtle to Spectacular: It's Your Choice

From subtle hues to eye-catching accents, Ultrashield's Naturale collection of colors and surface patterns delivers a palette of design options to create the customized look of Naturale wood that's perfect just for you.

Choose your look, assured of consistency of appearance from NewTechWood's collection, perfect for decking, siding, porches, railings, and even fencing that washes clean when the work is done.

Durable, easy-to-install, low-maintenance solutions to all of your outdoor construction needs.



**25 YEAR WARRANTY**

## The UltraShield® Comprehensive Warranty

Our Ultrashield® decking is backed by the most comprehensive warranty in the industry. NewTechWood stands behind its products, backed by a 25-year limited, transferable warranty.



# ULTRASHIELD RANGE



## UltraShield<sup>®</sup> ECO

Available in Driftwood, Hazelwood, Rosewood

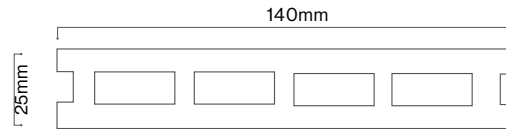

Board Dimensions: **140x25x3600mm**  
 Board Coverage: **0.525m<sup>2</sup>** (1m<sup>2</sup> = 1.90 boards)

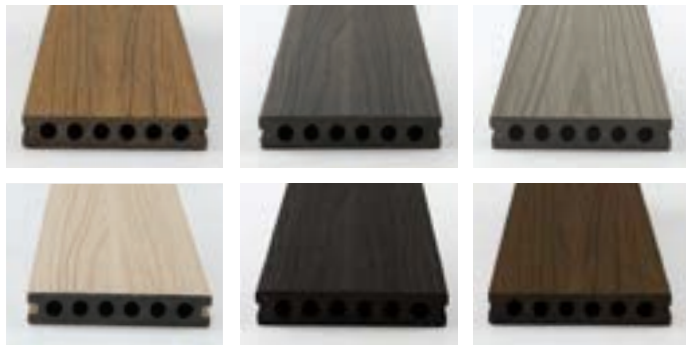

## UltraShield<sup>®</sup> NATURALE

Available in Teak, Silver Grey, Antique, Cedar, Ebony, Walnut

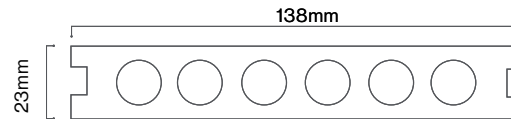

Board Dimensions: **138x23x3600mm**  
 Board Coverage: **0.512m<sup>2</sup>** (1m<sup>2</sup> = 1.95 boards)

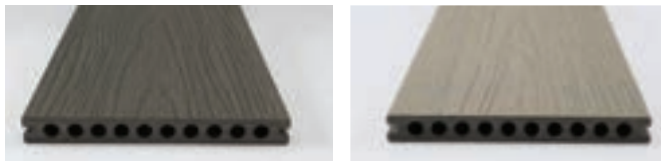

## UltraShield<sup>®</sup> NATURALE WIDE BOARD

Available in Pebble Grey and Old Mist

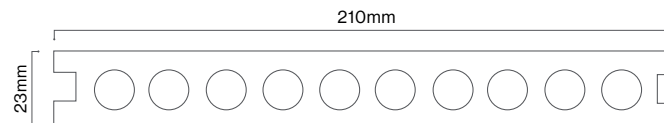

Board Dimensions: **210x23x3600mm**  
 Board Coverage: **0.774m<sup>2</sup>** (1m<sup>2</sup> = 1.29 boards)

ULTRASHIELD	RAL No
Naturale Cedar	1015
Naturale Walnut	8014
Naturale Teak	8024
Naturale Antique	7030
Naturale Silver Grey	7012
Naturale Ebony	9005
Naturale Wide Pebble Grey	7012
Naturale Wide Old Mist	7030
Eco Driftwood	7022
Eco Hazelwood	7011
Eco Rosewood	8004

*RAL Colour match is not an exact match due to texture and colour variation in the boards.*







# NEW UltraShield<sup>®</sup> ECO

Our new Ultrashield Eco composite deck board has all the familiar properties and advantages of our current Ultrashield Naturale board. The dimensions are slightly larger at 140mm x 25mm however the board length remains our standard 3600mm. It is available in Driftwood, Hazelwood and Rosewood colours. 138 x 10mm matching fascia boards also available.



Driftwood

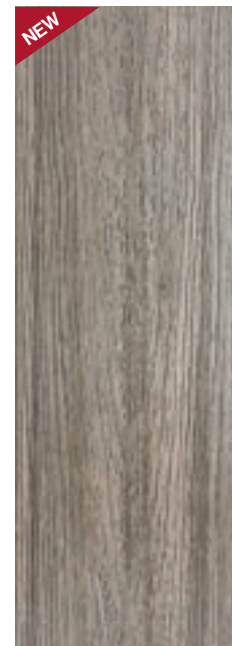

Hazelwood



Rosewood

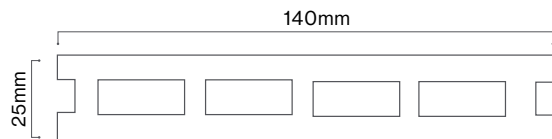

Board Dimensions: **140x25x3600mm** Board Coverage: **0.525m<sup>2</sup>** (1m<sup>2</sup> = 1.90 boards)

- ✓ Hidden Fixing System
- ✓ Finishing Trims Available
- ✓ 90% Recycled Material

*UltraShield, is a true game changer in the composite decking industry.*

**Note:** Due to the production process for Ultrashield decking board widths can vary slightly. Boards widths should be measured and matched accordingly







# UltraShield® Naturale™

Whiteriver UltraShield decking is a high performance, environmentally friendly alternative which offers the warmth and appeal of natural hardwoods in 6 deluxe colours: Silver Grey, Teak, Antique, Walnut, Ebony and Cedar. Whiteriver UltraShield will not splinter or crack, due to its protective shield, making your deck safer for bare feet, small children and pets.

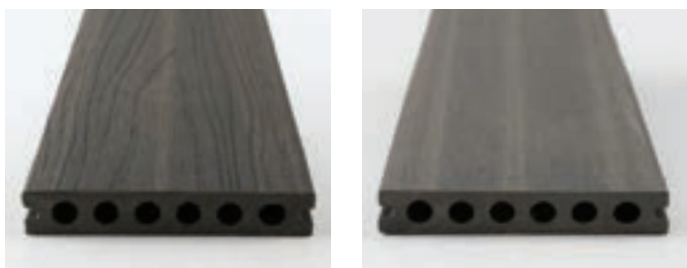

↻ Reversible Boards ↻

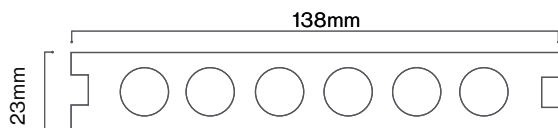



**Board Dimensions: 138x23x3600mm** **Board Coverage: 0.512m<sup>2</sup> (1m<sup>2</sup> = 1.95 boards)**

## Whiteriver ULTRASHIELD

### Real Wood Look!

Ultrasield delivers a **natural** look that makes it industry leader.

					
Side 1 Ebony Grained	Side 1 Silver Grey Grained	Side 1 Teak Grained	Side 1 Antique Grained	Side 1 Walnut Grained	Side 1 Cedar Grained
					
Side 2 Ebony Smooth	Side 2 Silver Grey Smooth	Side 2 Teak Smooth	Side 2 Antique Smooth	Side 2 Walnut Smooth	Side 2 Cedar Smooth

-  Hidden Fixing System
-  Finishing Trims Available
-  90% Recycled Material

*Whiteriver UltraShield, is a true game changer in the composite decking industry.*

**Note:** Due to the production process for Ultrasield decking board widths can vary slightly. Boards widths should be measured and matched accordingly













36

ULTRASHIELD NATURALE ANTIQUE 138 X 23 X 3600MM



ULTRASHIELD NATURALE SILVER GREY 138 X 23 X 3600MM





























ULTRASHIELD NATURALE ANTIQUE 138 X 23 X 3600MM



ULTRASHIELD NATURALE ANTIQUE 138 X 23 X 3600MM

















# UltraShield® Naturale™ wide board

The UltraShield Naturale Wide Board encompasses all the high performance features of the standard width board with the added perception of an expansive deck. Available in two colours - Old Mist and Pebble Grey.

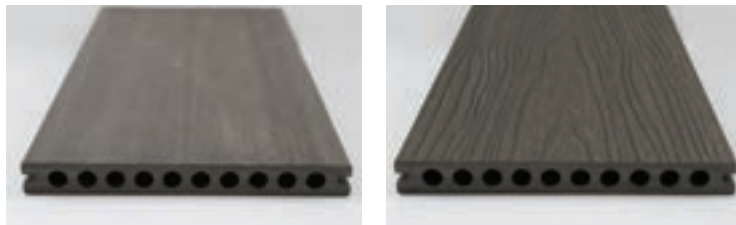

↔ Reversible Boards ↔

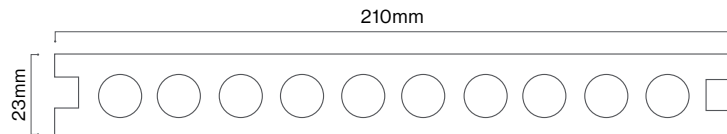

Board Dimensions: **210x23x3600mm** Board Coverage: **0.774m<sup>2</sup>** (1m<sup>2</sup> = 1.29 boards)

## Whiteriver ULTRASHIELD

### Real Wood Look!

Ultrasield delivers a **natural** look that makes it industry leader.



Old Mist - Grained Side 1



Pebble Grey - Grained Side 1

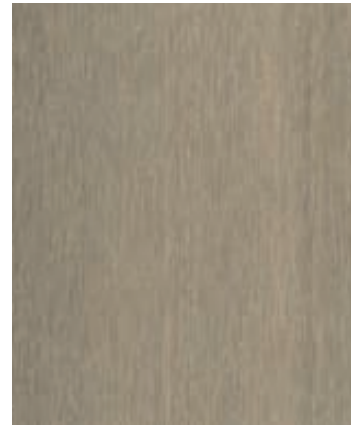

Old Mist - Smooth Side 2



Pebble Grey - Smooth Side 2

✓ Hidden Fixing System

✓ Finishing Trims Available

✓ 90% Recycled Material

*Whiteriver UltraShield is a true game changer in the composite decking industry.*

**Note:** Due to the production process for Ultrasield decking board widths can vary slightly. Boards widths should be measured and matched accordingly







ULTRASHIELD NATURALE PEBBLE GREY WIDE BOARD 210 X 23 X 3600MM









ULTRASHIELD OLD MIST WIDE BOARD 210 X 23 X 3600MM



## FINISHING TOUCHES







## FINISHING TOUCHES

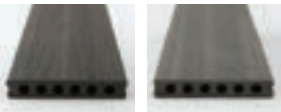

## ULTRASHIELD DECK BOARDS

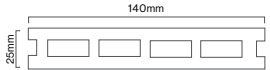
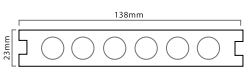
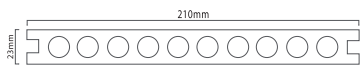
UltraShield <sup>®</sup> ECO	UltraShield <sup>®</sup> Natural	UltraShield <sup>®</sup> Natural Wide board
		
		
140 x 25 x 3600mm	138 x 23 x 3600mm	210 x 23 x 3600mm

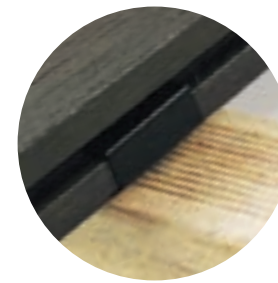

START/END CLIP

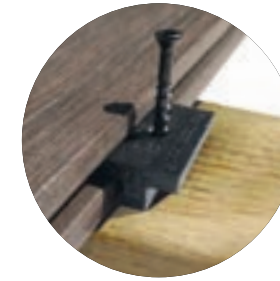

CLIP & SCREW



LOCKING CLIP



 One locking clip to be installed at the centre point of each board to control even expansion and contraction along the length of the board. The locking clip has teeth on one side to catch the board.

## JOIST OPTIONS

Composite Joist	Aluminium Joist	Aluminium Double Joist	Joist Support	Joist Corner Bracket	Joist Joining Bracket
Generally for use on balconies where structural height is not possible. Ventilation and drainage need to be carefully considered for balcony installations. This joist is not load bearing. <b>"MUST BE PREDRILLED"</b>	Lightweight, strong and durable. Provides long lasting alternative to wooden joist.	This joist provides support and drainage channel where two board ends meet.	Stainless steel support for aluminium joists.	Stainless steel bracket for reinforcing corner joints on aluminium joist.  <i>Pack of 4 with Tek screws</i>	Stainless steel bracket for joining aluminium joists.  <i>Pack of 4 with Tek screws</i>
					
			Stainless Steel 362mm for 400mm centres with 38mm joist		
40 x 25 x 3000mm	38 x 38 x 3000mm	75 x 38 x 3000mm	362mm	50 x 50mm	100 x 25mm



## FIXING COMPONENTS

<b>Installation Kit Timber Joist</b>	<b>Start/End Clip Timber Joist</b>	<b>Installation Kit Steel &amp; Aluminium Joist</b>	<b>Start/End Clip Steel &amp; Aluminium Joist</b>	<b>Stainless Steel Screws</b>
Secret fixings for securing boards to joists.	For securing first and last rows.	Contains self tapping screws.	Contains self tapping screws.	Contains colour matching screws. Composite material needs to be predrilled and screws should be counter sunk.
				
Includes 50 Clips & Screws and 8 Locking Clips (Covers 2.5m <sup>2</sup> ) (Covers 3.8m <sup>2</sup> for Wide plank)	25 per pack for first & last row	Includes 50 Clips & Screws and 8 Locking Clips (Covers 2.5m <sup>2</sup> ) (Covers 3.8m <sup>2</sup> for Wide plank)	25 per pack for first & last row	100 screws per pack colour coded screws for fixing fascia board. Note: Not Available in Cedar



PREDRILL COUNTER SUNK SCREW HOLES



INSTALLATION KITS



STAIR TREAD

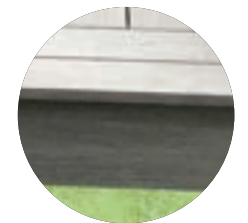



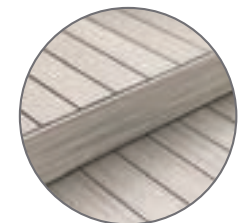

STAIR TREAD



FASCIA BOARD

## ULTRASHIELD TRIM OPTIONS

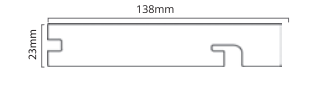
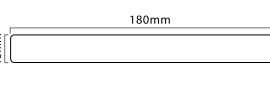
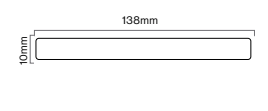
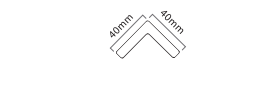
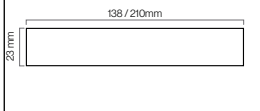
<b>Stair Tread</b> (Ultrashield Naturale)	<b>Fascia Solid Plank</b> (Ultrashield Naturale)	<b>Fascia Solid Plank</b> (Ultrashield Eco)	<b>Corner Wrap</b>	<b>End Cap</b>
Professional finishing edge board with concealed fixing ideal for steps and finishing deck perimeter.	Smooth board for a simple clean finish to hide structural framework.	Smooth board for a simple clean finish to hide structural framework.	Finishing trim for corners and edges - we do not recommend these to be use for step edges. Corner wrap should be predrilled and fixed to the substructure - not the decking.	Used for sealing and finishing exposed board ends - secure with outdoor silicone sealant.
				
				
138 x 23 x 3600mm	180 x 15 x 3600mm	138 x 10 x 3600mm	40 x 40 x 3600mm	138 x 23mm 210 x 23mm

Note: It is very important to provide ventilation to enter the under side of your deck when finishing off side trims.



**NewTechWood**

# Aluminium Railing

STURDY AND FAST TO INSTALL



## Aluminium hand rail system

AVAILABLE IN BLACK AND WHITE

Aluminium railing is known for its strength, durability and beauty. More and more homeowners these days are choosing Aluminium railing over traditional wood railing for its low-maintenance benefits. Aluminium does not rot, warp, or crack and it never needs to be stained, sanded or painted. It's also an excellent choice for the environment, as it's 100% recyclable and no harmful chemicals are required to treat or maintain it.

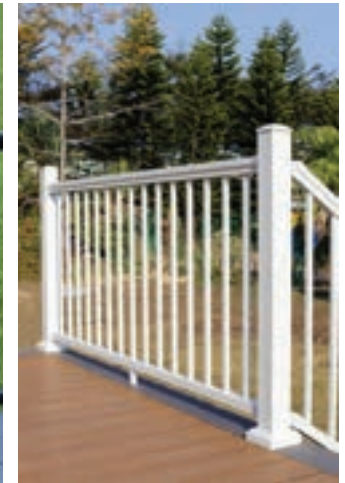
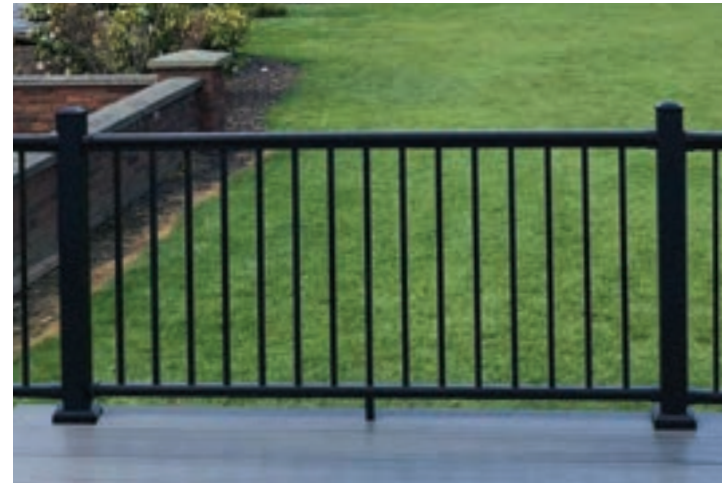





### WHY CHOOSE ALUMINIUM HANDRAIL SYSTEM?

There are several reasons why Ultrashield Aluminium deck railing is an excellent idea for your deck:

**Quick assembly:** The rails come pre assembled which reduces installation time.

**Quality appearance:** A deck railing in traditional black or white colour will give your deck a more complete and upmarket look you are sure to love.

**Colour finish:** The Aluminium railing has a high quality powder coated finish.

<p>PRE-ASSEMBLED STRAIGHT RAIL SECTION 1829mm Wide Includes brackets to fix to post.</p>	 <p>K1730001 White</p>
<p>PRE-ASSEMBLED STAIR RAIL SECTION 1829mm Long. Spindles pivot between top &amp; bottom rails to allow gradient adjustment. Includes adjustable swivel brackets to fix to post.</p>	 <p>K1730006 White</p>
<p>1010MM POST Includes cap &amp; base flange. Must be fixed to sub-construction - not directly to deck boards. Fixings not included.</p>	 <p>K1730011 White</p>
<p>TOP &amp; BOTTOM SWIVEL CONNECTORS Allows handrail to be installed at angle instead of straight installation. Contains 1 top &amp; 1 bottom rail bracket.</p>	 <p>K1730051 White</p>

Aluminium

# White Railing

Complete system with easy to use components

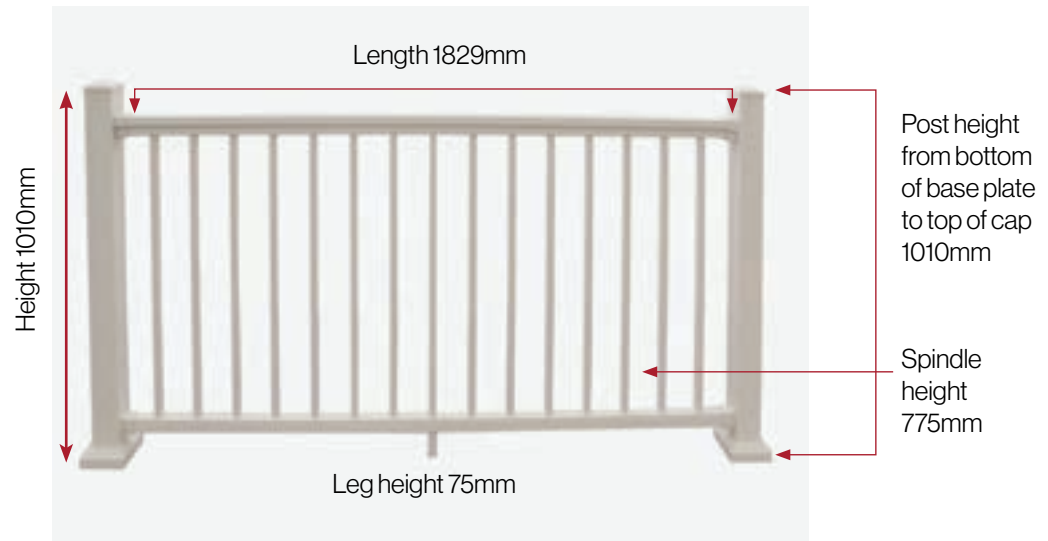

White railing.

Base Flange Covers Fixings



NOTE: The handrail can only be used at a maximum deck height of 600mm above ground level. Full installation instructions available at [www.wrg.ie](http://www.wrg.ie)



**PRE-ASSEMBLED / 50% FASTER INSTALLATION**

ULTRASHIELD

Whiteriver

Aluminium

# Black Railing

Complete system with easy to use components

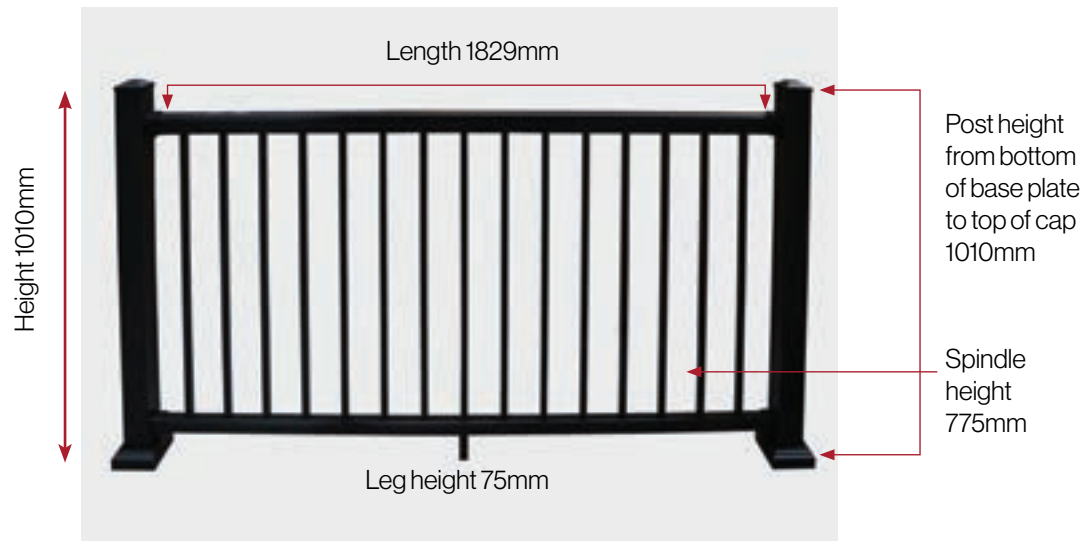

Black railing.

<p>PRE-ASSEMBLED STRAIGHT RAIL SECTION 1829mm Wide Includes brackets to fix to post.</p>	<p>K1710001 Black</p>
<p>PRE-ASSEMBLED STAIR RAIL SECTION 1829mm Long. Spindles pivot between top &amp; bottom rails to allow gradient adjustment. Includes adjustable swivel brackets to fix to post.</p>	<p>K1710006 Black</p>
<p>1010MM POST Includes cap &amp; base flange. Must be fixed to sub-construction - not directly to deck boards. Fixings not included.</p>	<p>K1710011 Black</p>
<p>TOP &amp; BOTTOM SWIVEL CONNECTORS Allows handrail to be installed at angle instead of straight installation. Contains 1 top &amp; 1 bottom rail bracket.</p>	<p>K1710051 Black</p>

**NOTE: The handrail can only be used at a maximum deck height of 600mm above ground level. Full installation instructions available at [www.wrg.ie](http://www.wrg.ie)**



Pedestals offer great flexibility for installation and can be used for decking and paving. They are especially helpful where the installation is close to ground level, pedestals can be used for build ups from 17mm up to 1000mm.

Please note that for composite decking we recommend the installation be at least 100mm above ground level. Pedestals also provide for good air movement under a deck provided ventilation points are installed.



# PEDESTALS

BY WHITERIVER

**SOLIDOR**™ a European manufacturer of high quality pedestals for decking and concrete paving. The pedestals can be continuously adjusted in height from 17mm to 1000mm. The durability of the plastic and the solidity of the construction guarantee a smooth installation in all circumstances, and an unprecedented supporting power.



Made From Recycled Material



Weatherproof



Temperature Resistant between -25 / +70°C



Certificates CSTC / CSTC No., DE, ATA



Load Bearing 800kg per Pedestal



PP Compound

## CAN ALSO BE USED FOR PAVING

### COVERAGES GUIDE

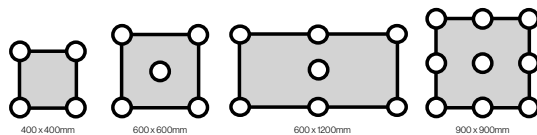

- Paving pedestals are recommended for slabs with a minimum size of 400x400mm, in accordance with the instructions of the paving manufacturer.
- Paving formats larger than 600x600mm will need an extra pedestal in the centre of the slab, please seek advice from your paving manufacturer as this will vary depending on thickness and overall strength of each paving slab.

## DECKING COVERAGE GUIDE

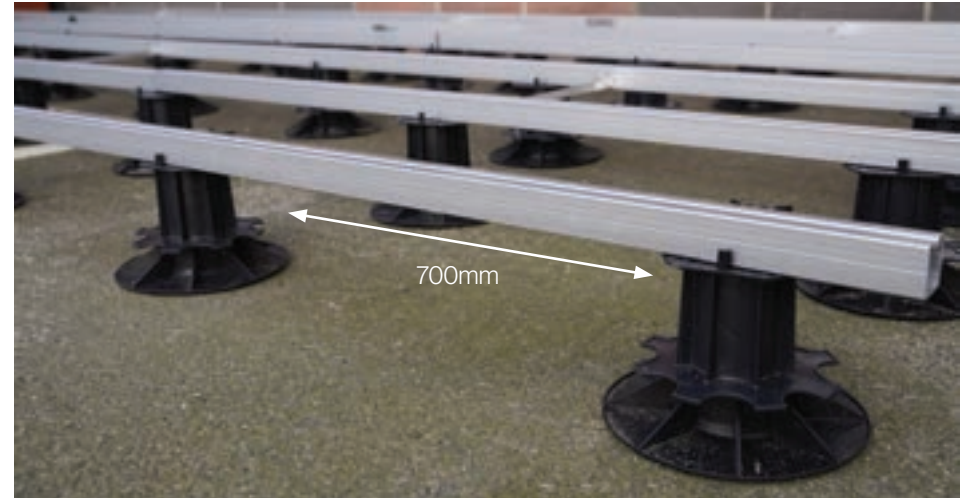

Spacing depends on joist strengths. 700mm spacing shown is for Whiteriver 38mm Aluminium Joists.

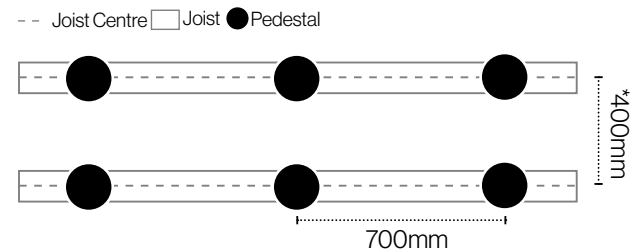

\*300mm centres for commercial installations

**BASED ON THE ABOVE DIAGRAMS  
WE RECOMMEND APPROX. 6.0 PEDESTALS PER M<sup>2</sup>**

Pedestal spacing can be from 500mm to 1000mm along the joist length, however this depends on the application and joist strength. Whiteriver Aluminium joist can be used at 700mm Pedestal Spacing.

### STEP 1

Once you know your height required, pick your base. It may be a case that you need a mixture of pedestal bases, if there are different heights within your project.

<p>35MM - 50MM ADJUSTABLE PEDESTAL BASE</p>   <p><b>PV 3.5/5</b> PRICE EXCLUDES SUPPORT PLATE</p> <p><b>K1420016</b></p>	<p>50MM - 80MM ADJUSTABLE PEDESTAL BASE</p>   <p><b>PV 5/8</b> PRICE EXCLUDES SUPPORT PLATE</p> <p><b>K1420017</b></p>	<p>80MM - 110MM ADJUSTABLE PEDESTAL BASE</p>   <p><b>PV 8/11</b> PRICE EXCLUDES SUPPORT PLATE</p> <p><b>K1420018</b></p>	<p>110MM - 140MM ADJUSTABLE PEDESTAL BASE</p>   <p><b>PV 11/14</b> PRICE EXCLUDES SUPPORT PLATE</p> <p><b>K1420019</b></p>	<p>140MM - 170MM ADJUSTABLE PEDESTAL BASE</p>   <p><b>PV 14/17</b> PRICE EXCLUDES SUPPORT PLATE</p> <p><b>K1420020</b></p>	<p>35MM - 50MM ADJUSTABLE PEDESTAL BASE <i>For use against wall</i></p>   <p><b>AK 3.5/5</b> PRICE EXCLUDES SUPPORT PLATE</p> <p><b>K1420021</b></p>	<p>50MM - 80MM ADJUSTABLE PEDESTAL BASE <i>For use against wall</i></p>   <p><b>AK 5/8</b> PRICE EXCLUDES SUPPORT PLATE</p> <p><b>K1420022</b></p>
--	--	--	--	--	--	--

### STEP 2

Pick the plate to go on top of your base. CPV+ is for timber and aluminium joists.

<p>JOIST SUPPORT PLATE WITH SIDE FIXING</p>   <p><b>CPV+</b> MAX. JOIST WIDTH 78MM</p> <p><b>K1420026</b></p>	<p>FLAT SUPPORT PLATE WITHOUT GUIDE</p>   <p><b>CO</b> FOR ADDITIONAL SUPPORT WHERE REQUIRED</p> <p><b>K1420006</b></p>	<p>PAVING SUPPORT PLATE</p>   <p><b>C3/4T</b> PAVING SUPPORT PLATE WITH 3MM SPACERS</p> <p><b>K1420007</b></p>
---	---	--

### STEP 3

Consider if any accessories are needed. Most common are extension pieces. Extension pieces can be used to bring pedestals up to 1m.

<p>FRICITION PAD <i>For top of pedestal</i></p>  <p><b>2MM FRICITION PAD</b> FOR USE WITH PAVING SUPPORT PLATE</p> <p><b>K1420010</b></p>	<p>30MM PEDESTAL EXTENSION PIECE</p>  <p><b>F30</b> MAX HEIGHT 8 PER PEDESTAL</p> <p><b>K1420023</b></p>	<p>100MM PEDESTAL EXTENSION PIECE</p>  <p><b>AF100</b> MAX HEIGHT 10 PER PEDESTAL</p> <p><b>K1420009</b></p>	<p>210 X 210 X 3MM PROTECTION PAD <i>For under pedestal</i></p>  <p><b>PROTECTION PAD</b> FOR SURFACE, SOUND &amp; SHOCK ABSORBING PROTECTION. CAN ALSO BE USED AS SHIM FOR LEVELLING.</p> <p><b>K1420025</b></p>	<p>SLOPE CORRECTOR</p>   <p><b>HS2</b> REDUCES INCLINATION DIFFERENCES FROM 2% TO 10% BY STACKING</p> <p><b>K1420015</b></p>
--	---	---	--	--



### STEP 1

Select an adjustable base 17mm to 23mm.

17MM - 23MM ADJUSTABLE PEDESTAL BASE



P17  
PRICE EXCLUDES SUPPORT PLATE

K1420027

Our Premium low height range allows you to raise joists by as little as 17mm for an ultra low secure base for your project. The 3mm, 5mm & 10mm small rubber pads, can be used to support joists where the height requirement is < 17mm. Note: always remember to deduct the joist thickness plus finish product thickness from overall finished height required. For composite decking we recommend 100mm air space under the boards.\*



\*For low height build up please seek advice.



Low pedestal solutions.

### STEP 2

Pick the plate to go on top of your base. C2V+ is for timber and aluminium joists.

C2V+ JOIST SUPPORT PLATE	C4T PREMIUM PAVING SUPPORT PLATE
	
C2V+ MAX. JOIST WIDTH 90MM	C4T PAVING SUPPORT PLATE WITH 3MM SPACERS
K1420028	K1420029

### STEP 3

Consider if any accessories are needed. Most common are extension pieces, and joist support pads.

5MM EXTENSION PIECE	96MM X 96MM JOIST SUPPORT PAD
	
S5 MAX HEIGHT 2 PER PEDESTAL	Use directly under joists to build up heights < 17mm
K1420030	3MM - K1420031 5MM - K1420032 10MM - K1420033



Pedestals give great flexibility for installations and make it easy to allow decking and paving to be installed easily in the same area.



Joist joining bracket

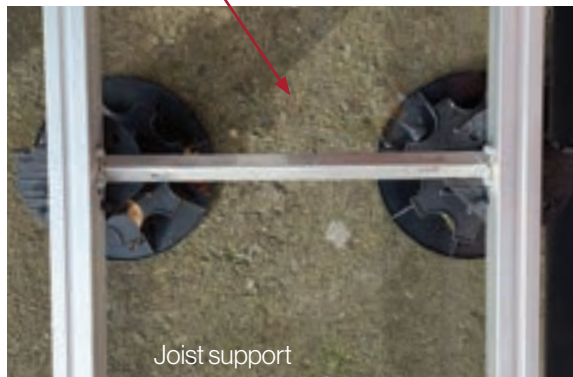

Joist support

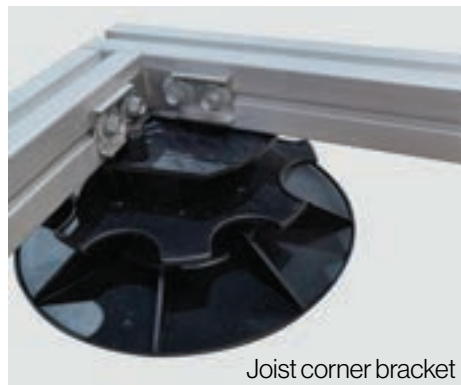

Joist corner bracket

**Step 1** - Understand the spacing's required for the finished product going on top. For composite decking in residential setting using our 38mm aluminium joist, the spacing for the aluminium joist will be 400mm centres and the pedestal spacing will be 700mm.

**Step 2** - Remember when planning to take account of the direction you want the boards to run, the board length and finishing look around the perimeter. Composite decking requires a fall of 1.66% (1:60 fall) for water to drain off the boards.

**Step 3** - Building the frame for your composite decking – Set out pedestals and joist per above. Each pedestal should be screw fixed to the aluminium joist. Joiner brackets should be used where aluminium joists meet – leave a 4mm gap for expansion and drainage. Stabilisation joist supports can be used on outer frames; note it is not necessary to do these on every row.

**Step 4** - Double Aluminium joist can be used where board ends meet. The wide joist allows each board to be fixed with its own clip and any water can drain in the U shaped channel.

**Step 5** - Finishing perimeter – Corner brackets can be used with the aluminium joist to create a side frame. Remember to provide for ventilation for underneath your deck. Please look at the vents we offer.

**Step 6** - All screw fixings for aluminium can be predrilling. For ease of installation we recommend tek screws and tek screw driver which are available from most Hardware stores. Aluminium can be pre drilled to make it easier for installing the tek screws.

**Please refer to [www.wrg.ie](http://www.wrg.ie) for our full installation guidelines for composite decking.**

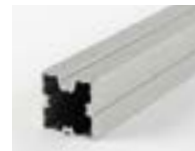

38 x 38 x 3000mm  
Aluminium Joist



75 x 38 x  
3000mm  
Aluminium  
Double Joist



362mm  
Joist Support for  
400mm centres  
with 38mm joist



Joist Corner  
Bracket



Joist Joining  
Bracket



## WHITERIVER SINGLE AND DOUBLE ALUMINIUM JOIST SYSTEM

Double Aluminium Joist provides for **rain water** run off at board end

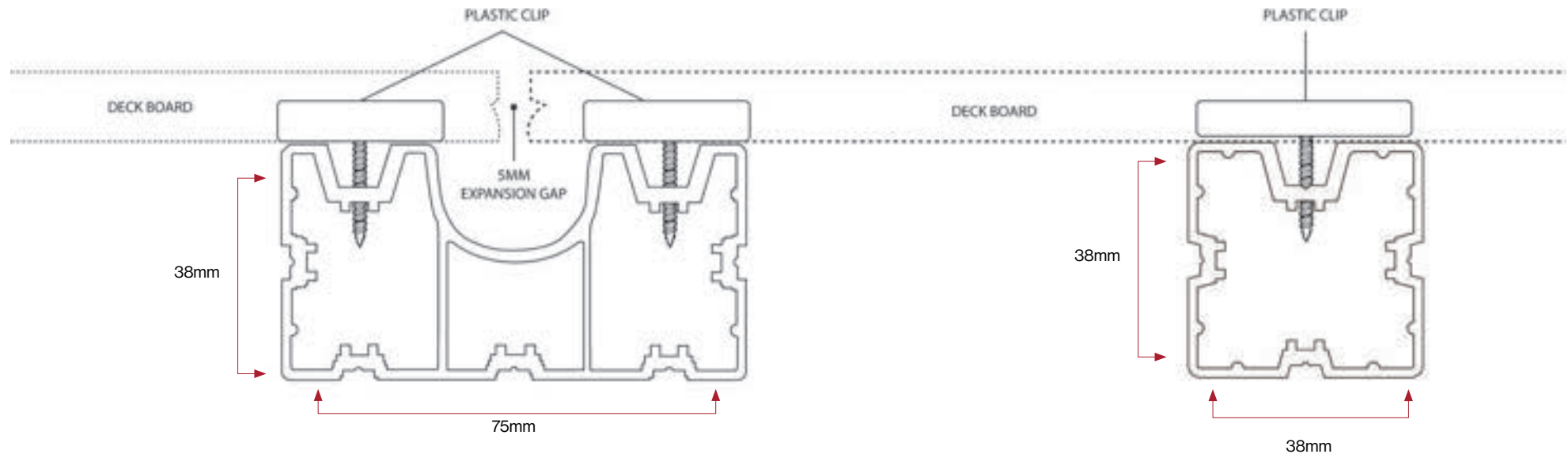

- 1 The Aluminium double joist should be used where two board ends meet.
- 2 The double joist provides stability for the fixing clips.
- 3 Remember to leave 5mm expansion gap.
- 4 The main reason for using the double joist is that it helps prevent moisture soaking into the board ends.
- 5 In a normal installation format, **you need approx. 20% of your joists to be double joists.\***
- 6 It is very important to leave 5mm gap at joist ends so water can drain away freely.

**NOTE: 25mm x 5mm Stainless Steel Tek Screws need to be sourced separately for fixing plastic pedestal and aluminium joists. We recommend planning the location first of your double joist.**

\*It is best to sketch out your deck layout and this will tell you clearly the number of double joists you need.

## Planning Your Deck

Designing and building a deck can be a fun and a rewarding experience. You probably have given some thought as to what you want in a deck, now is the time to really visualise it. What will your deck be used for, relaxing, entertaining, will you put garden seating, BBQ, tables with a parasol on it and how many people might you have on your deck? Will there be children and elderly people using it?

### These are the questions you need to look at before starting.

- (1) Where will I install the deck?
- (2) What size do I want the deck?
- (3) Which deck board do I like best?
- (4) Which direction should the boards run?
- (5) Which substructure will I use: Hardwood, \*Steel or Aluminium joists?  
\*Steel / Aluminium joists >2mm: A hole must be pre drilled in the joist and specific Steel Joist Installation Kits must be used.

Follow the fitting instructions carefully, see full instructions on [www.wrg.ie](http://www.wrg.ie) technical information before starting.

## Location and Deck Size

When deciding the size of your deck, look around at the space you have, your house, the size of your garden and what proportion of deck will enhance and improve the look of it. Your deck should have a southerly aspect. Is the ground level or falling? How close to the house would I like the deck? When deciding on the size of deck you need to take into account that the deck boards are 3600mm in length. You can make a deck any length, but you want to avoid having a deck with very short end boards. Therefore it's important to plan your exact deck layout.

## Tools Required

Whiteriver Decks can be installed using the same tools that you would use for fitting any timber deck. • Tape Measure • Electric Saw • Level • Square • Cordless Drill • drill bits • Building Line • Safety Goggles

## General

Composite decking has a composition of 60% timber, 30% HDPE Plastic and 10% Resins / Pigments etc. While the timber element is very stable (it is kiln dried at very high temperatures to remove the cell structure), the HDPE expands and contracts on the length of the board in line with changes in temperature and humidity. It is necessary to leave a perimeter gap of 10mm around where the deck meets fixed objects/obstructions and also a 5mm spacing must be left at each short board end to allow for normal seasonal movements.

## Design

Once you have made a decision on the above, now you need to decide on the deck design. A deck that is well designed can do amazing things to your home.

First decide on the direction you would like the boards to run please note boards must drain along the length of the board, the minimum fall required is 1.66% (1:60 fall) to allow water drain off the boards e.g. a 5 metre deck should have a fall of 83mm across the deck. **Do not install the decking flat.** Will there be steps? Would you like handrails around it? What colour will suit your garden and house best?

## Ventilation and Site Conditions

There should be good drainage under the deck and all topsoil should be removed and replaced with clean stone, unless the deck is at least 1000mm above ground level with open ventilation under the deck. No soil should meet the deck boards or under structure. The ground/substructure should be properly supported - please consult with an engineer if you are unsure. Whiteriver composite decking products CANNOT be directly installed onto a flat surface. It must be installed onto a substructure, so there is adequate and unobstructed air flow under the decking to prevent excessive water absorption.

**Good ventilation under your deck is key to it performing well in the long term.**

For non screed and screed surfaces, plan a minimum of 100mm (4 inches) of continuous net free area under the decking surface. This is required to allow for adequate ventilation on all deck types so air can circulate freely between adjacent joist members to promote drainage and drying. Air must have an entry point and exit point to the sub construction.

Joist should be built up on two criss cross layers or the joist should be supported with plastic pedestals to allow for air movement. For small balcony areas, less than 10m<sup>2</sup>, it is possible to have a lower clearance provided sufficient drainage and air movement can be provided. For balcony projects, we recommend getting the design reviewed by an engineer.

Please note areas that are walled in on all sides are not suitable for deck installation as there will not be enough air movement under the deck, unless ventilation through the walls is provided for the undercarriage. If there is any dampness under the deck, it can lead to mould build up underneath the deck and excessive swelling, expansion and contraction in the boards. In summary, it is vital that the area underneath the deck is free draining and per above, adequate ventilation is provided for.

If you require any technical advice, please contact our sales office on **Email: [enquiries@wrg.ie](mailto:enquiries@wrg.ie)**



## Direction of Deck

There is no correct deck direction, it is purely personal preference but whatever you choose dictates the sub-frame design and configuration. Things to consider: Think about where you or your guests will view the deck. Looking along the length of the boards will make the deck look longer, while looking across the boards creates an illusion of width. All boards are 3600mm long and each side of the board contains different groove or pattern.

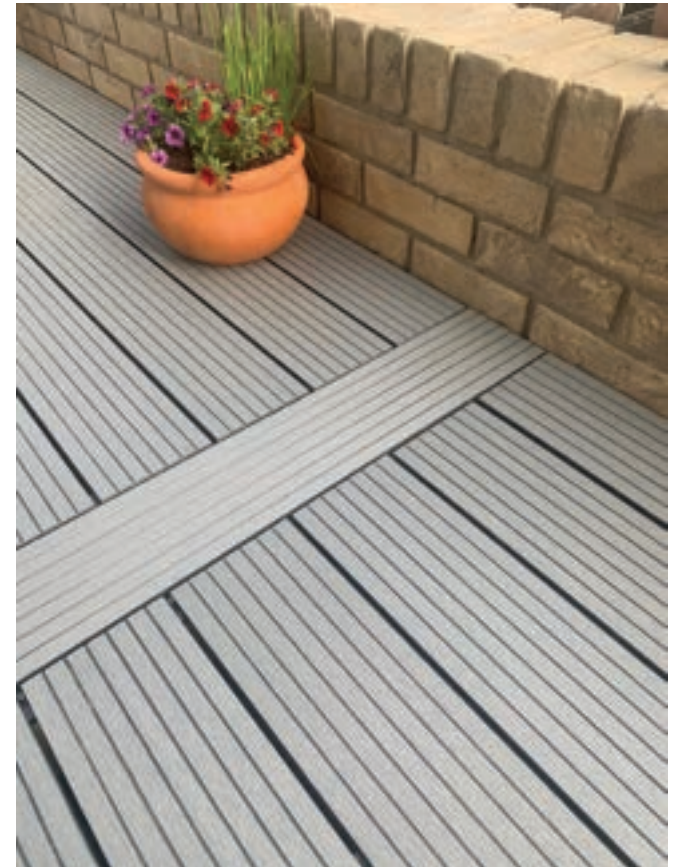
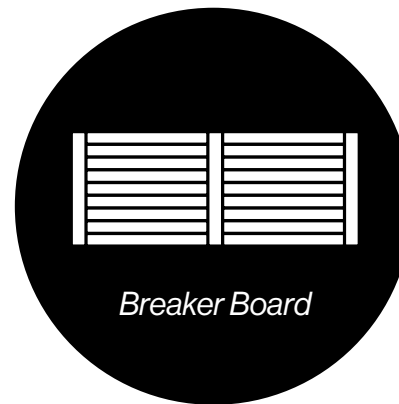
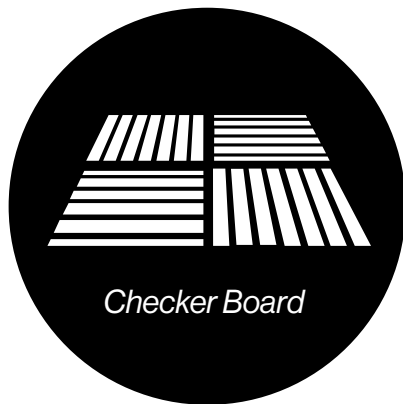

# Composite Decking Installation Do's & Don'ts

Please read the instructions fully before starting to install. Failure to install composite decking correctly will result in the deck becoming structurally unstable.

A 10mm gap around the whole deck must be left for expansion and a 5mm gap between board ends.

 <p>LEAVE A 10MM GAP AROUND DECK PERIMETER TO ALLOW FOR MOVEMENT</p>	 <p>ENSURE THERE IS GOOD AIR CIRCULATION AROUND AND UNDER THE WHOLE DECK</p>	 <p>LEAVE A 5MM EXPANSION GAP BETWEEN BOARD ENDS</p>	 <p>DOUBLE JOIST WHERE BOARD ENDS MEET. EACH BOARD END SHOULD HAVE ITS OWN CLIP &amp; JOIST</p>
 <p>USE STEEL INSTALLATION KITS FOR FIXING TO STEEL OR ALUMINIUM JOISTS</p>	 <p>USE GOOD QUALITY JOISTS OR ALUMINIUM. PRE DRILL FASCIA BOARDS BEFORE FIXING</p>	 <p>USE RECOMMENDED CLIPS TO SECURE BOARDS TO JOISTS</p>	 <p>PRE DRILL STEEL JOISTS TO RECEIVE STAINLESS STEEL SCREWS</p>
 <p>ACCLIMATISE BOARDS TO THE ENVIRONMENT FOR 3 DAYS PRIOR TO INSTALLATION</p>	 <p>LEAVE A NATURAL FALL TO ALLOW WATER TO DRAIN OFF BOARDS</p>	 <p>USE LOCKING CLIPS TO CONTROL EVEN EXPANSION &amp; CONTRACTION ALONG THE LENGTH OF THE BOARD</p>	 <p>20MM MAX. OVERHANG FROM JOIST AT DECK EDGES WITH LAST FIXING CLIP MAX 30MM FROM BOARD END</p>
 <p>SCREW DIRECTLY THROUGH BOARDS AND COMPOSITE JOISTS</p>	 <p>STORE BOARDS ON SOLID OR UNEVEN SURFACES</p>	 <p>INSTALL IN AREAS THAT HAVE WALL ON ALL SIDES</p>	 <p>LEAVE BUTT JOINTED AND CUT ENDS UNSEALED</p>



Bridging supports can be put in as required.

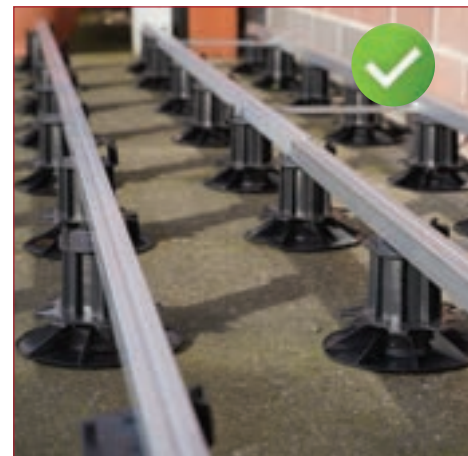

A structurally sound sub frame must be installed ensuring there is no movement prior to fixing boards to the joists. A 1.66% (1:60) fall to allow water to drain and a minimum 100mm free air space between the boards and the ground beneath to allow sufficient airflow to prevent the build up of moisture is essential.





Composite decking should only be installed using correct clips and fixings. Failure to do this will affect the structure of the deck as well as warranty. Never screw directly through the boards. Steel joists >2mm must be pre drilled and specific Steel Joist Installation Kits must be used.

Note: Due to the production process for Ultrashield decking board widths can vary slightly. Boards widths should be measured and matched accordingly.



The overhang of the board should be a maximum of 20mm.



Joists must be set to a maximum of 400mm centres for Portland and Ultrashield Eco (350mm Ultrashield Naturele and Wide Plank). This is to ensure stability and also to avoid warping and cracking of the deck boards.

Note: 300mm are recommended for commercial installations.



Board ends butted together must be supported by separate joists and have a min 5mm gap for expansion, or use Aluminium Double Joist. Failure to do this may result in structural failure, swelling and warping. There should be a spacing gap left between the double joists to allow rainwater/debris to fall through the boards.

# Key points on how to fit your composite decking correctly.

Following on from our Dos and Don'ts we explain the issues that can arise if decks are not installed or maintained correctly.



## **What happens if I leave soil under my deck area ?**

The soil will retain a lot of moisture and this will affect your decks performance. You need to remove the soil and then stone the area below your deck. You also need to ensure the area is free draining. If your deck is being raised by more than 1m and the area is being left completely open underneath the ground type is less important.

## **What happens if water pools under my deck ?**

Similar to the reasons mentioned above for soil, it will have a negative affect on your substructure and deck boards performance. If in a balcony area, it may be a sign that there may be a blocked drain.

## **What happens if I fit my deck flat with no fall ?**

If you fit your deck flat, the water will not be able to drain off your deck boards easily and your deck will remain wet for much longer periods after it rains. This will cause your deck to catch more dirt and will also encourage over time mould growth to develop.

## **What happens if I fit my deck with north or east facing orientation ?**

Your deck will get much less sun light and will be more prone to being damp and wet for longer. If you are fitting in a north facing area, your deck will require more regular cleaning.

## **What happens if I don't provide ventilation under my deck ?**

The area under your deck will become damp and this may cause your substructure to rot or corrode over time, the decking will also expand and contract a lot more as the excess moisture will pass into the decking boards. Your substructure therefore needs ventilation for 2 reasons.



For full installation instructions and tips, Please scan the QR code to visit our website.

[www.wrg.ie](http://www.wrg.ie)



# Avoid installation errors.

## **What happens if I don't leave expansion gap of 5mm at board ends or 10mm around perimeter walls ?**

Composite decking will expand and contract as the climate changes. If there is no room for the boards to expand, they will push against each other or the wall and eventually they will develop cracks.

## **What happens if I don't use a double joist where board ends meet ?**

The reason you use a double joist where board ends meet is that the water can drain off the board ends freely and fall to the ground. The board ends are also properly supported with clips. If the board ends are left resting on the joist there is the risk that they will absorb excess moisture causing the boards ends to swell and expand.

## **What happens if I don't use one locking clip per board that is provided in the installation kit ?**

The boards may gradually slide along the normal clips and leave a big gap at one end. The teeth on the locking clip help control the boards movement, it is vital that one clip with teeth catches each board close to its mid-point.

## **What happens if I screwfix other items through the deck boards ?**

This will create a pressure point and the boards may crack over time as there may not be enough expansion room. Handrail systems should always be fixed to the substructure and not through the deck boards.

## **What happens if I don't clean my deck ?**

Your deck will remain fine in the short term but over time the deck will collect dirt and pollen and eventually as the deck gets dirtier there will be some green or black mould growth. Your deck never needs to be painted or sealed but it is important to have a cleaning programme.



We hope this information helps you understand why getting your deck installation correct is the key to you having a great outdoor area to enjoy.

# Installation Guide

- Make sure you have ordered enough material, so as not to be short. Allow for about 5% waste. Diagonal installations will have a higher waste factor.
- Store decking on site for at least 3 days, raised off the ground, lying flat and keep it dry.
- Ensure there is adequate ventilation under the deck. Air should have an entry point and exit point to the sub construction.
- Make sure you allow for expansion of the deck. An expansion gap of 5mm must be allowed where board butt ends meet and a 10mm gap should be left where boards meet fixed points e.g. walls, pillars or railing posts. No objects should be fixed directly to/through the deck as this will prevent seasonal movement. These should be fixed to the substructure.
- Due to the production process for Ultrashield decking board widths can vary slightly. Boards widths should be measured and matched accordingly.
- Each board end must sit on it's own independent joist with a 5mm expansion gap at board ends per above. There should be a 10-25mm gap between each joist to allow for water/ debris to fall straight through.
- There should be good drainage under the deck.
- There should be a minimum fall of 1.66% (1:60) along the deck boards to allow for water to drain freely.
- It is essential to use a locking clip on the joist nearest the centre of every board. This minimises the amount of expansion that the board can do.
- Whiteriver decking is approved for use over joist centres of maximum 400mm/16" (300mm/12" in commercial use) for Portland and Ultrashield Eco. Max. 350mm centre to centre for Ultrashield Naturale and Wide Plank (300mm in commercial use).
- Cantilever / overhang of deck board from joist at deck edges should be no greater than 20mm with the last securing clip no more than 30mm from board end to prevent cupping.
- Read the full set of instructions on [www.wrg.ie](http://www.wrg.ie) technical information before starting.

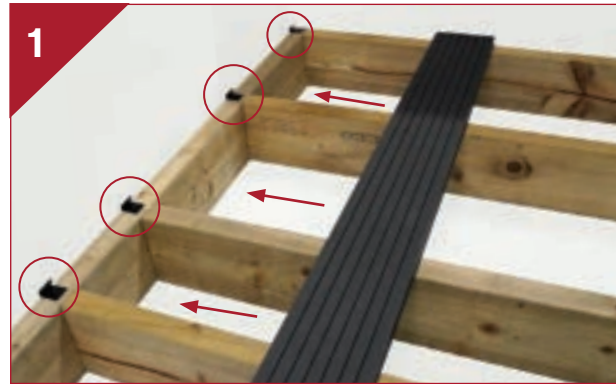

Secure start/end clips in line with each joist. Please note an expansion gap of 10mm must be placed around any fixed objects within the decking e.g. stair case, post brackets and any permanent fixtures that may prevent the decking expanding and contracting naturally. Where two boards join together on the first row, a starter/end clip must be used on each board with a 5mm expansion gap on the short end. Hollow deck boards are not suitable for face fixing. Push the first deck board into the start/end clip. Check that the board is straight and fully inserted into the clip.

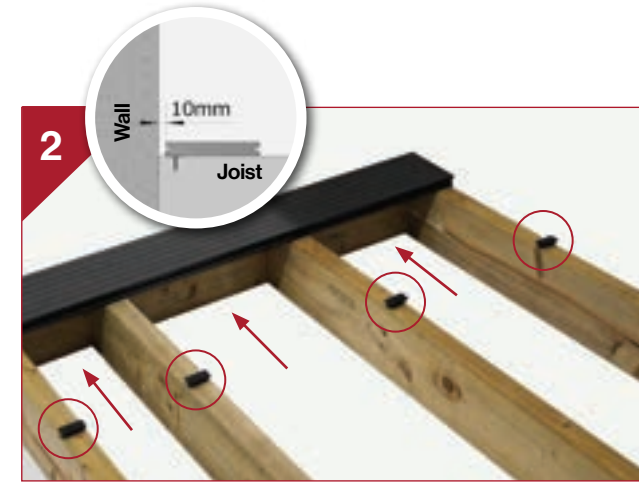

Insert a standard clip into each deck board in line with joist and screw fully but do not over tighten.

**Note: A locking clip will need to be installed on each deck board per point 4.**



Push the second row of boards into the previous installed row of boards making sure that the deck board grooves are in tight on the clips. Continue to keep inserting clips and boards in this way (using one locking clip per board).



It is very important to install one locking clip per board onto the joist nearest the centre of the board. This helps maintain a consistent expansion gap at the short ends. Failure to use the locking clip will result in uneven gapping at short ends. **Attn: Each board only requires one locking clip in the middle. The teeth should always face the same direction.**



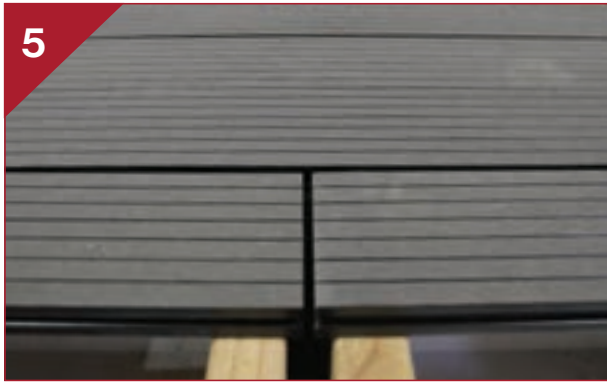

When butt jointing boards along the length of the deck you must leave a 5mm gap for seasonal expansion and contraction - see diagram above. Note comments on point 6 regarding double joisting. Boards must not meet across one single joist and must be sealed to prevent swelling, cupping and splitting.



All board ends should be on their own independent joists or if using Aluminium joist, make sure to use our Aluminium Double Joist with its own clip i.e. when butt jointing boards, sister joisting must be used. **This is to ensure that the board will not slide off the joist - failure to do so will void the warranty. Also there needs to be a minimum of 10-25mm between the sister joists per diagram for water to go down between the joists or swelling could occur at the ends.** UltraShield board ends meeting across sister joists should be sealed with a polyurethane matt exterior varnish to prevent end swelling, cupping and splitting.

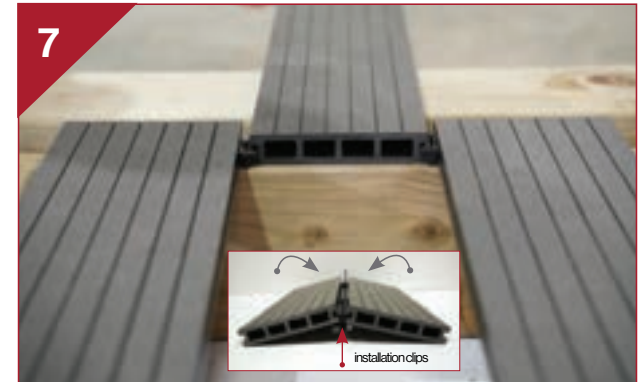

If not framed by wall or building on each side, the second last row of boards can be slid into position after you have fixed the last row and the clips for the second last row have been fixed into position.

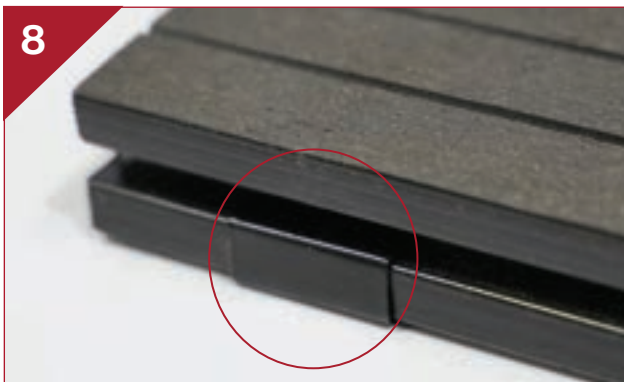

For the last row of boards use a start/end clip in line with each joist. You need to use these clips even if you putting on a fascia board. If you can not slide in the board, the boards can be fixed with screw at 45 degree angle.

**Important: the screw hole must be predrilled.**



You can use a solid fascia plank for a great looking finish. It is very important to predrill all composite material prior to fixing with a hole slightly bigger than the screw. Fix in two stainless steel screws into the substructure at intervals of 300-400mm - the fascia must be predrilled with a countersunk hole and fixed to a solid timber plank in all areas (not directly to the butt ends of exposed joists). **You must leave a minimum 40mm gap between the bottom of the fascia and the ground to allow for ventilation.**

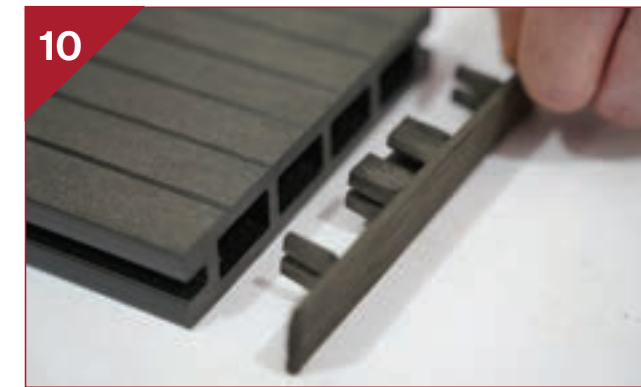

Moisture can penetrate to the core in the end-cut area and could cause swelling, cupping and cracking at the edge area. Our end pieces are made from durable material with high impact resistance under harsh weather conditions. To prevent moisture penetration we recommend:

**Nevada solid board:** Seal all cut ends with a water based polyurethane matt exterior varnish to the full surface of all end-cuts.

**Hollow boards:** End Pieces should be used at perimeter and sealed all round with outdoor silicone sealant.

**Note: It is very important to provide ventilation to enter the under side of our deck when finishing off the side trims. Once your deck is finished, please ensure to protect your deck until all other trades are finished.**

# Breaker Board Installation

Diagrams below show how framework and installation of the breaker board respectively. The framework uses a ladder joist installation where the user is building a frame perpendicular for the board that will be running down it.

**The below breaker board design ensures the water runs off the board end and down between the joists. The board ends should not rest on the timber as it will absorb moisture.**



**Important:** All Ultrashield board ends meeting the breaker board or at deck end should be sealed with a water based polyurethane matt exterior varnish to prevent moisture penetrating the board core. The boards should be predrilled with a 3mm drill bit before screws are fixed at 45 degree angle to fix the breaker board. Its important to predrill before screwing as this prevents the boards cracking later. A starter clip can be used on one side of breaker boards.

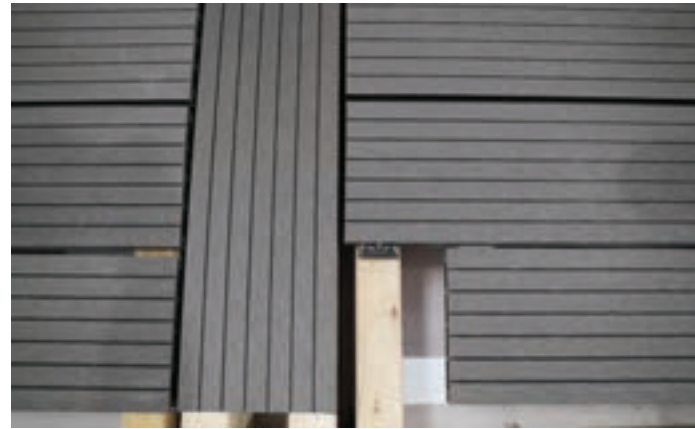

**Note: Gap for water to run off board ends to the ground.**

# Fascia Board Installation

*Installing against the width and length of decking*

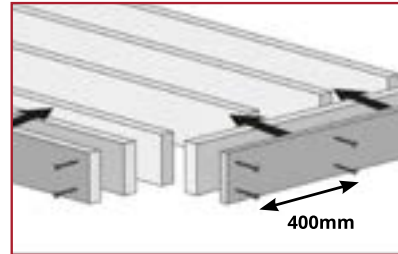

Fascia boards need to be fixed at installed on 400mm centres to prevent warping or buckling. All fascias need to use two screws 40mm away from the ends regardless of the thickness.

First, pre-drill 3mm holes in the fascia board before face fixing with screws. This drilling allows for the fascia board to expand and move slightly. The fascia board will then be installed into the joist or side board.

**Note: NEVER install the fascia by drilling into the decking ALWAYS install the fascia into the joist and ALWAYS pre-drill the fascia with a countersunk hole.**

**Good ventilation under the deck is key to it performing well in the long term. DO NOT close off air flow around the perimeter of the deck by fixing fascia too close to the ground. Provide vents if needed.**

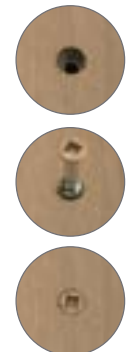



# Stair Tread Installation

Stair treads must meet requirements by Government Building Standards - please consult Department of Housing, Planning and Local Government.

A minimum of four (4) stringers are required. Overhang on a stair tread should not exceed more than 16mm.

Joist centres on steps are 300mm.

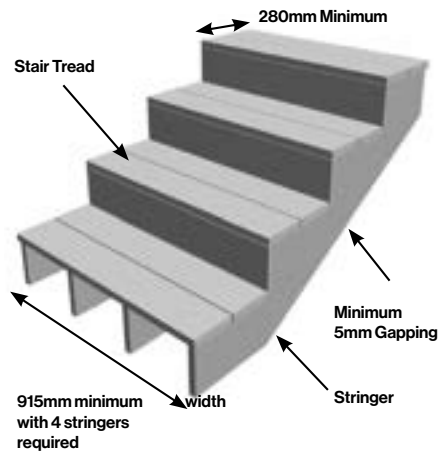

First, determine how many boards your stair is going to take to finish (including clip spacing of 6mm between boards) and then you can start to measure where the starter clip will go. Use a white chalk line (NEVER USE COLOURED CHALK) to ensure that all starter clips are lined up on each joist as shown in **Diagram 1**.

**Note: The stair tread board can only cantilever/overhang 16mm. If this is exceeded the warranty will be voided.**

Place stair tread board over all the starter clips and push down as shown in **Diagram 2**.

Now that the starter clips are inside the underside of the stair tread, the final step is to push forward to ensure that it is secured into place as shown in **Diagram 3**.

Now take the next board and have it situated behind the stair tread board as shown in **Diagram 4**.

Slide the clips into the two grooves and glide them along until they are on their respective joists and then screwing down onto the joists as shown in **Diagram 5 & 6**.

Finally, finish your last board by face fixing into the board at every joist as shown in **Diagram 7**.

**Note: Remember to pre-drill before face fixing into the board. Also face fixing must happen at a 90 degree angle and must be at least 40mm by 40mm from the ends and the width of the board. All pre-drilling must be with a countersunk bit.**

**Diagram 8** shows a completed staircase from the side to get a better idea of how the final installation will look.

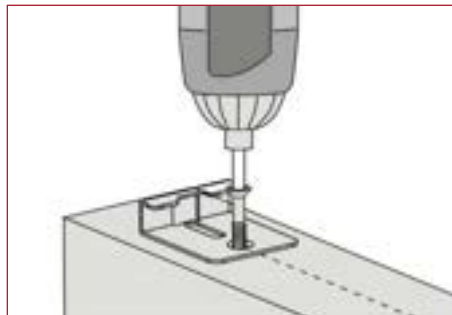

**Diagram 1**

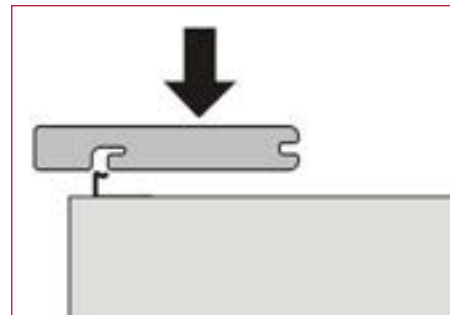

**Diagram 2**

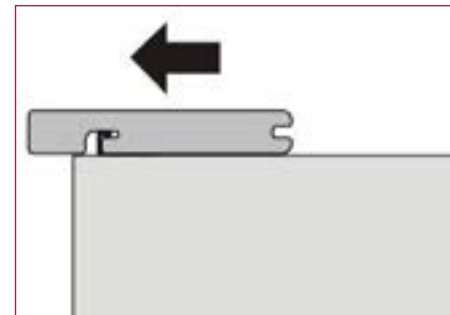

**Diagram 3**

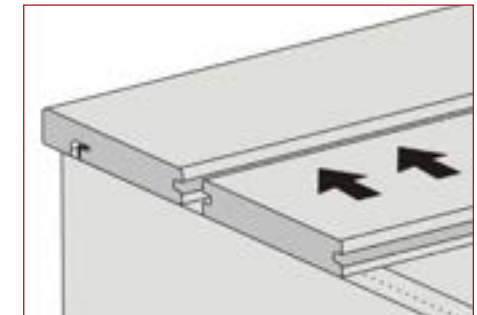

**Diagram 4**

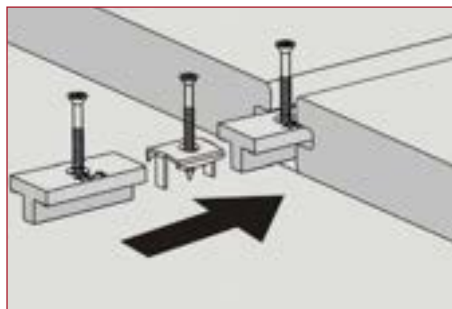

**Diagram 5**

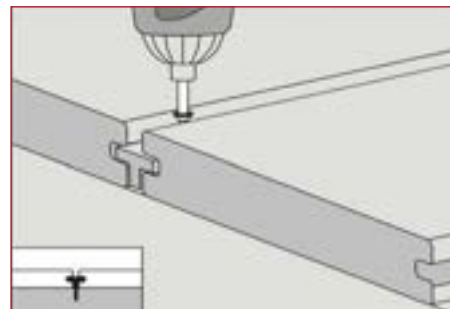

**Diagram 6**

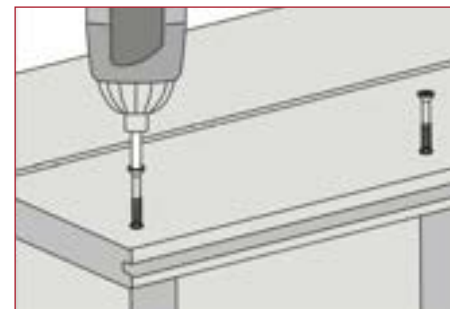

**Diagram 7**

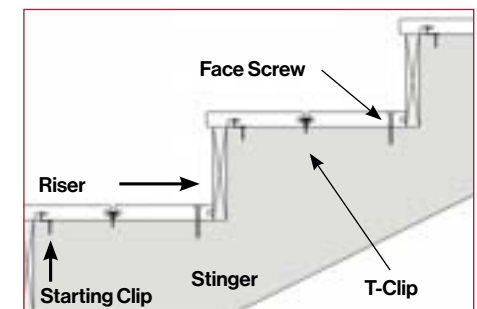

**Diagram 8**



NewTechWood

# INTRODUCING UltraShield<sup>®</sup> Cladding



- ✓ Hidden Fixing System
- ✓ Finishing Profiles available
- ✓ 90% Recycled Material

Installation is simple using our range of innovative accessories.

Treated timber battens with a minimum thickness of 22mm should be fixed to the wall at 500mm centres. The starting rail is then fixed along the bottom to give an even starting point and support the first row of cladding. Every consecutive row is then secured using the specially designed clips resulting in a seamless finish. Rubber stoppers are used behind the final row to ensure boards are kept flush when fixed with colour matching screws. Corner and edge trims are used to complete the installation.

*AN ELEGANT LOW MAINTENANCE  
ALTERNATIVE.*

See [www.wrg.ie](http://www.wrg.ie) for full installation instructions. Do not install without reading the full instructions.

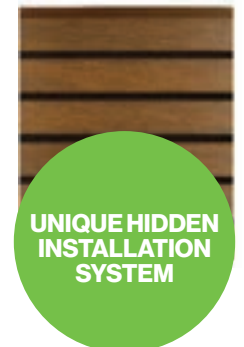

**UNIQUE HIDDEN  
INSTALLATION  
SYSTEM**



# COMPOSITE CLADDING

A few **good** reasons to choose  
**UltraShield Cladding**

Our Ultrashield cladding looks like natural wood, without the worries of real wood exposed to the elements. Ultrashield cladding installs quickly using our exclusive clip system that creates a lasting seal between planks.

Our installation system enables your building to “breathe” as air circulates between boards and joists, keeping your building high, dry, and energy efficient.

- MADE FROM 90% RECYCLED MATERIALS
- NATURAL TIMBER LOOK & FEEL
- EASY TO INSTALL

**ULTRASHIELD**  
**25** YEAR LIMITED WARRANTY

Acc. to Whiteriver terms - see wrg.ie for full details.

For technical data information, please consult our website - [www.wrg.ie](http://www.wrg.ie)





ULTRASHIELD TEAK CONTEMPORARY

**Cladding Calculator Estimator (No. of boards required)**

Product	10m <sup>2</sup>	12m <sup>2</sup>	14m <sup>2</sup>	16m <sup>2</sup>	18m <sup>2</sup>	20m <sup>2</sup>	22m <sup>2</sup>	24m <sup>2</sup>	26m <sup>2</sup>	28m <sup>2</sup>	30m <sup>2</sup>	32m <sup>2</sup>	34m <sup>2</sup>	36m <sup>2</sup>	38m <sup>2</sup>	40m <sup>2</sup>	42m <sup>2</sup>	44m <sup>2</sup>	46m <sup>2</sup>	48m <sup>2</sup>	50m <sup>2</sup>
Contemporary Cladding - 2700mm	20	24	28	32	36	40	44	48	52	56	60	64	68	72	76	80	84	88	92	96	100
Contemporary Cladding - 3600mm	15	18	21	24	27	30	33	36	39	42	45	48	52	55	58	61	64	67	70	73	76

*Above excludes waste factor - 11 clips required per square metre.*





Acc. to Whiteriver terms - see wrגיע for full details.

# NEW UltraShield® Contemporary Cladding

## Suitable for Garden & Home

Why settle for bare brick or plastered external walls which need constant painting when you can have the contemporary look and feel of natural timber with our low maintenance composite cladding. With easy installation, plus low maintenance, and rugged durability that stands up to any weather conditions, this is the ideal finish to enhance the beauty of the exterior of your home. Installation is easy with our unique invisible clip system that creates a lasting seal between each piece. Available in Teak, Silver Grey & Walnut.

**Made from the same 90% recycled material as our UltraShield Decking, our Cladding is environmentally friendly and made to last with a 25 year limited warranty.**



Contemporary cladding teak



Contemporary cladding silver grey



Contemporary cladding walnut

<b>Contemporary Cladding Teak</b>
196.5 x 25 x 2700mm - K1630006
196.5 x 25 x 3600mm - K1630001
<b>Contemporary Cladding Silver Grey</b>
196.5 x 25 x 2700mm - K1630106
196.5 x 25 x 3600mm - K1630101
<b>Contemporary Cladding Walnut</b>
196.5 x 25 x 2700mm - K1642006
196.5 x 25 x 3600mm - K1642001

5.43 linear meters of board covers 1m<sup>2</sup>

## Installation & Accessories

<p><b>3000mm EXTERNAL CORNER UH60 TRIM</b></p> <p>K1630016 Teak - K1630116 Silver Grey K1642016 Walnut</p>	<p><b>3000mm EDGE UH59 TRIM</b></p> <p>K1630011 Teak - K1630111 Silver Grey K1642011 Walnut</p>	<p><b>3000mm JOINER UH70 TRIM</b></p> <p>K1630021 Teak - K1630121 Silver Grey K1642021 Walnut</p>

<p><b>STARTING RAIL</b></p> <p>K1650001</p>	<p><b>CLADDING CLIP</b> Approx. 11 clips and screws per sq.m</p> <p>K1650006</p>	<p><b>RUBBER STOPPER</b></p> <p>K1650011</p>	<p><b>COLOUR MATCHING SCREWS</b></p> <p>For securing last row. Cladding should be predrilled with a countersunk hole before fixing with screws. "Select Colour"</p>
Individual lengths - 3000mm	50 per pack with fixing screws	10 per pack with fixing screws	100 per pack

**IMPORTANT:** Please check our cladding installation instructions on our website - technical information [www.wrg.ie](http://www.wrg.ie)

**Note:** Please consult local building / fire regulations before planning or commencing installation.



ULTRASHIELD SILVER GREY CONTEMPORARY

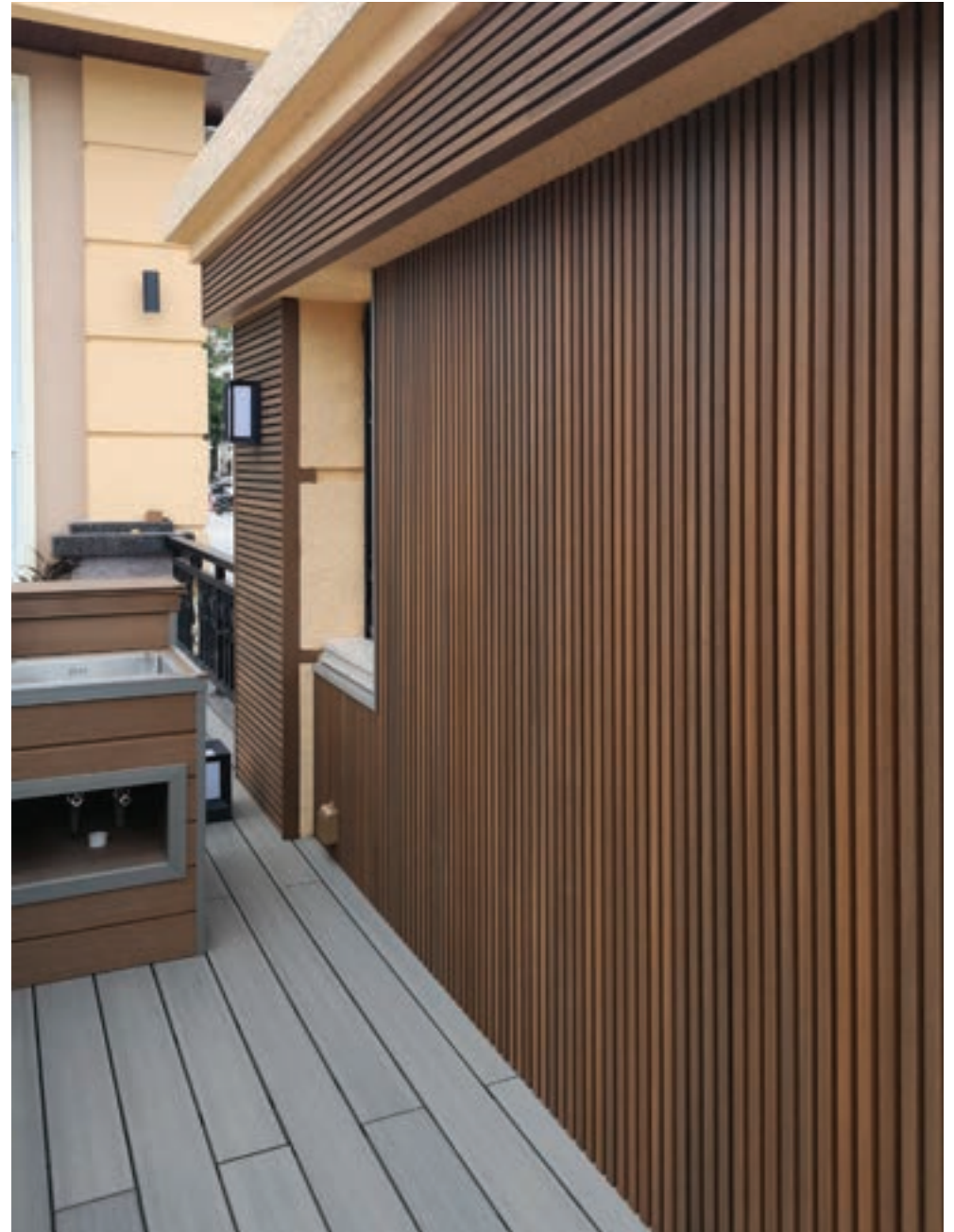

ULTRASHIELD WALNUT CONTEMPORARY







ULTRASHIELD SILVER GREY TRADITIONAL

**Cladding Calculator Estimator (No. of boards required)**

Product	10m <sup>2</sup>	12m <sup>2</sup>	14m <sup>2</sup>	16m <sup>2</sup>	18m <sup>2</sup>	20m <sup>2</sup>	22m <sup>2</sup>	24m <sup>2</sup>	26m <sup>2</sup>	28m <sup>2</sup>	30m <sup>2</sup>	32m <sup>2</sup>	34m <sup>2</sup>	36m <sup>2</sup>	38m <sup>2</sup>	40m <sup>2</sup>	42m <sup>2</sup>	44m <sup>2</sup>	46m <sup>2</sup>	48m <sup>2</sup>	50m <sup>2</sup>
Traditional Cladding - 2700mm	28	34	39	45	51	56	62	68	73	79	85	90	96	101	107	113	118	124	130	135	141
Traditional Cladding - 3600mm	21	25	30	34	38	42	46	51	55	59	63	68	72	76	80	84	89	93	97	101	105



# NEW UltraShield® Traditional Cladding

UltraShield wall cladding is the ultimate solution for exterior walls because it combines the toughness and longevity of a capped wood plastic composite with an engineered design. The shield gives the wall cladding unbeatable colours and textures, with highly stain & UV resistance, making it long lasting and ultra low maintenance.

Siding guards your home against harsh weather conditions and extreme temperatures. Siding protects the inside of your home from wind, rain and snow. Siding can also keep dirt and insects outside. Installing your siding correctly ensures the ultimate protection.





Traditional cladding teak



Traditional cladding silver grey



Traditional cladding walnut

<b>Traditional Cladding Teak</b>

142 x 13 x 2700mm - K1610006
142 x 13 x 3600mm - K1610001
<b>Traditional Cladding Silver Grey</b>

142 x 13 x 2700mm - K1610016
142 x 13 x 3600mm - K1610011
<b>Traditional Cladding Walnut</b>

142 x 13 x 2700mm - K1610056
142 x 13 x 3600mm - K1610051

7.40 linear meters of board covers 1m<sup>2</sup>

## Installation & Accessories

<p><b>3000mm END US44 TRIM</b> K1620001 Teak K1620021 Silver Grey K1640021 Walnut</p> 	<p><b>3000mm JOINER US45 TRIM</b> K1620006 Teak K1620026 Silver Grey K1640031 Walnut</p> 	<p><b>3000mm OUTSIDE CORNER US46 TRIM</b> K1620011 Teak K1620031 Silver Grey K1640011 Walnut</p> 	<p><b>3000mm INSIDE CORNER US47 TRIM</b> K1620016 Teak K1620036 Silver Grey / K1640016 Walnut</p> 	<p><b>STARTING RAIL</b> K1650001</p>  <p>Individual lengths - 3000mm</p>	<p><b>CLADDING CLIP</b> Approx. 15 clips and screws per sq.m K1650006</p>  <p>50 per pack with fixing screws</p>	<p><b>RUBBER STOPPER</b> K1650011</p>  <p>10 per pack with fixing screws</p>	<p><b>COLOUR MATCHING SCREWS</b> For securing last row. Cladding should be predrilled with a countersunk hole before fixing with screws. K1650006</p>  <p>100 per pack</p>
---	--	--	--	---	---	---	---

**IMPORTANT:** Please check our cladding installation instructions on our website - technical information [www.wrg.ie](http://www.wrg.ie)

**Note:** Please consult local building / fire regulations regarding your type of use before planning or commencing installation.



ULTRASHIELD TEAK TRADITIONAL









ULTRASHIELD SILVER GREY TRADITIONAL



# Installation tips

## Our cladding offers two orientations:

**Vertical cladding:** Boards run vertically, emphasizing height. Made with durable materials.

**Horizontal cladding:** Boards run horizontally, creating a broader look. Board width affects appearance.



Visit our website for detailed installation and check our comprehensive and easy-to-follow instructions on composite cladding and decking.

## Tips to calculate your area

Traditional - 142 x 13 x 2700mm = 0.355m<sup>2</sup>

Traditional - 142 x 13 x 3600mm = 0.474m<sup>2</sup>

Contemporary - 196 x 25 x 2700mm = 0.50m<sup>2</sup>

Contemporary - 196 x 25 x 3600mm = 0.67m<sup>2</sup>

Use full lengths or use joiner trim for longer runs where board ends need to meet.



For full installation instructions and tips, Please scan the QR code to visit our website.

[www.wrg.ie](http://www.wrg.ie)

## Cladding Calculator (No. of boards required)

Product	10m <sup>2</sup>	12m <sup>2</sup>	14m <sup>2</sup>	16m <sup>2</sup>	18m <sup>2</sup>	20m <sup>2</sup>	22m <sup>2</sup>	24m <sup>2</sup>	26m <sup>2</sup>	28m <sup>2</sup>	30m <sup>2</sup>	32m <sup>2</sup>	34m <sup>2</sup>	36m <sup>2</sup>	38m <sup>2</sup>	40m <sup>2</sup>	42m <sup>2</sup>	44m <sup>2</sup>	46m <sup>2</sup>	48m <sup>2</sup>	50m <sup>2</sup>
Traditional Cladding - 2700mm	28	34	39	45	51	56	62	68	73	79	85	90	96	101	107	113	118	124	130	135	141
Traditional Cladding - 3600mm	21	25	30	34	38	42	46	51	55	59	63	68	72	76	80	84	89	93	97	101	105

Product	10m <sup>2</sup>	12m <sup>2</sup>	14m <sup>2</sup>	16m <sup>2</sup>	18m <sup>2</sup>	20m <sup>2</sup>	22m <sup>2</sup>	24m <sup>2</sup>	26m <sup>2</sup>	28m <sup>2</sup>	30m <sup>2</sup>	32m <sup>2</sup>	34m <sup>2</sup>	36m <sup>2</sup>	38m <sup>2</sup>	40m <sup>2</sup>	42m <sup>2</sup>	44m <sup>2</sup>	46m <sup>2</sup>	48m <sup>2</sup>	50m <sup>2</sup>
Contemporary Cladding - 2700mm	20	24	28	32	36	40	44	48	52	56	60	64	68	72	76	80	84	88	92	96	100
Contemporary Cladding - 3600mm	15	18	21	24	27	30	33	36	39	42	45	48	52	55	58	61	64	67	70	73	76

# Our product ranges

We are also Ireland's leading distributor of laminate flooring, engineered real wood flooring and internal doors. Our brochures are available in your local builder's merchant, hardware store and flooring & door specialists.

You can also download them through our website [www.wrg.ie](http://www.wrg.ie).



Engineered Wood Flooring



Laminate Flooring

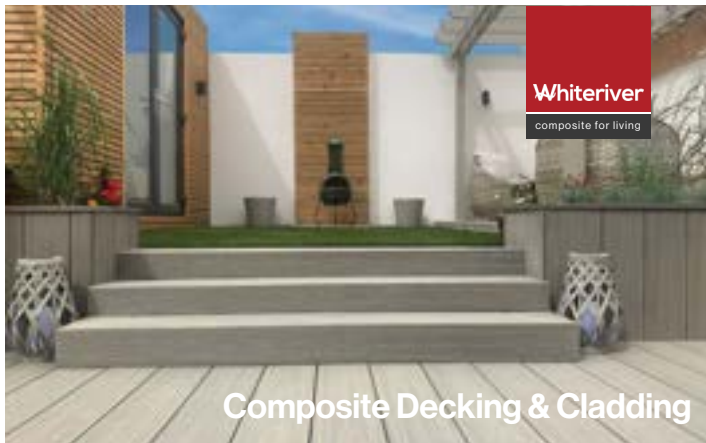

Composite Decking & Cladding



seadec  
doors for living...



# Our websites

Visit our websites for the latest product updates, inspirational galleries and brochures.  
[www.wrg.ie](http://www.wrg.ie) (Decking & Flooring) and [www.seadec.ie](http://www.seadec.ie) (Internal Doors & Mouldings)

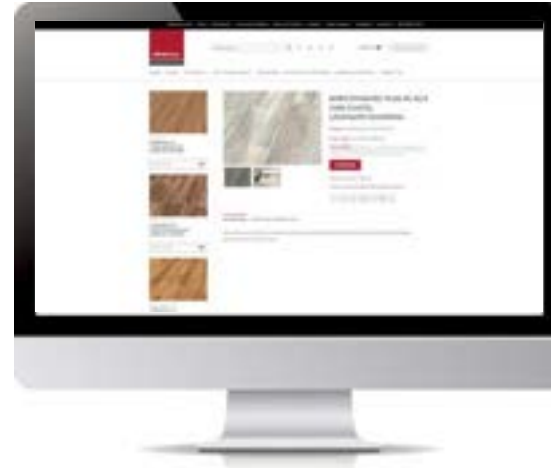

## Quality & Assurance

Full care & maintenance guides, DOP's, specification sheets and installation instructions are available through our websites and by request from our sales team [sales@wrg.ie](mailto:sales@wrg.ie) / [seadec@wrg.ie](mailto:seadec@wrg.ie)

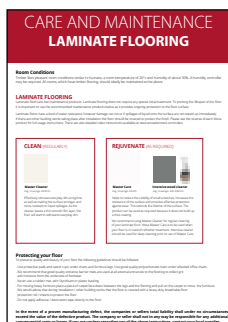

CARE AND MAINTENANCE

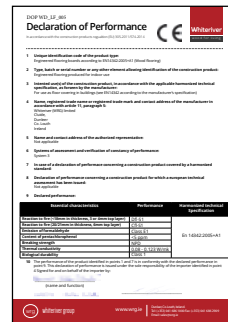

DECLARATION OF PERFORMANCE

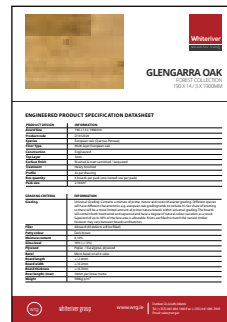

SPECIFICATION SHEET

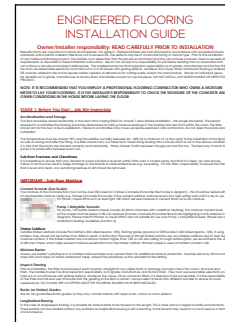

INSTALLATION INSTRUCTIONS

# F.A.Q.'S ON DECKING

## **IS WHITERIVER DECKING REALLY LOW MAINTENANCE?**

Yes there is no need for any annual treatment but your deck needs to be cleaned regularly. See Care & Maintenance for further information. For the best maintenance its advised to wash with soap based cleaner, gentle power washing is allowed but not advised on Ultrashield. North and east facing decks as well as decks where there is planting/leaves nearby will require more frequent attention.

## **DO WHITERIVER DECKS REQUIRE VENTILATION & DRAINING?**

Yes, it is similar to timber and it needs ventilation to the sub construction to dry out after getting wet. Air should have an entry point and exit point to the sub construction. A lack of ventilation can cause the deck to swell over time over time and affect the lifespan/integrity of the sub-construction if timber.

## **DO WHITERIVER DECKS SPLINTER?**

Whiteriver decks do not splinter.

## **DO WHITERIVER DECK BOARDS CUT LIKE WOOD?**

Yes you can use the same tools that you would use for a wooden deck.

## **DOES WHITERIVER DECK COST MORE THAN WOOD?**

In the short term it does, however when you compound the maintenance you have to do on wood every year the costs really add up. In a short time you will be able to see all the time and money you would have saved by using Whiteriver Decking.

## **HOW IS THE DECK SECURED?**

With hidden clips, see fitting instructions.

## **WHAT JOIST SPACES DO YOU USE?**

For domestic decks we recommend 400mm centres for Portland and 350mm for Ultrashield and for a commercial deck or heavy traffic area we recommend 300mm.

## **WILL THE DECK FADE BECAUSE OF SUN EXPOSURE?**

You can expect that there will be minor fading of up to 20%. The majority of this will happen over the first 10-12 weeks.

## **IS WHITERIVER DECKING IMPERVIOUS TO MOULD?**

Whiteriver decking has mould inhibitors that prevent mould growing on the inside of the board. Surface mould can still happen, however it will never penetrate the board itself. Mould and mildew can be washed off, or treated with a cleaner called AlgoClear, please follow instructions fully.

## **DOES WHITERIVER DECKING HAVE A WARRANTY?**

Yes, there is a 10 year residential limited warranty on our Portland range and 25 year residential limited warranty on our UltraShield ranges. See website for full details [www.wrg.ie](http://www.wrg.ie)

## **WHAT SHOULD I DO WITH THE ULTRASHIELD SCRAP PIECES?**

We recommend that you can use these in a variety of ways such as making planters, sand boxes, raised flowers beds, shelving etc.

## **CAN THERE BE STAINING?**

Staining can occur thus it is important to clean up any spillage as soon as it happens.

## **CAN I FIX DECK TO STEEL?**

Yes you can but please bear in mind that steel can expand and contract. Specific Steel Joist installation kits are available and joists must be pre drilled. Please see detailed fitting instructions to find out more on [www.wrg.ie](http://www.wrg.ie).

## **HOW DO I FIT HANDRAILS?**

Handrails and posts must be fixed to the substructure - see detailed fitting instructions on [www.wrg.ie](http://www.wrg.ie).

## **IS IT SCRATCH-RESISTANT?**

Whiteriver deck can present some scuff marks and scratches if negative contact is made. We recommend using castor cups under furniture legs.

## **HOW SHOULD I STORE AND HANDLE MY DECKING?**

Whiteriver decks should be stored on site for at least 3 days before fitting in a dry flat area and under cover.

## **CAN STATIC OCCUR?**

Static electricity is a naturally occurring phenomenon and may occur on composite decks depending on environmental conditions. Static in composite boards will generally decrease as boards age. Dryer vents and heat pumps in the area of the decking may also contribute to the generation of static.



# CARE AND MAINTENANCE

**GENERAL CLEANING:** Keep it clean and your Whiteriver composite decking will reward you with years of low maintenance pleasure. Periodic cleaning of Whiteriver composite decking is suggested, even if it appears clean, as it is important to prevent the build-up of pollen / debris that can cause mould. If unsure about the product being used to clean / remove stains from your deck, it is recommended that you test a small area in an inconspicuous place to determine if the product will cause any unwanted discolouration. Below is a more detailed instructions for taking care of your deck.

## **DIRT, GRIME AND DEBRIS:**

Clean your deck regularly to remove debris, pollen, and dirt. Use a soft non-metal deck brush, warm water and a mild household cleaner to scrub in the direction of the grain. Rinse thoroughly with a garden hose. For heavier dirt, a low bar pressure washer with wide fan tips can be used, but always wash in the direction of the grain along the length of the board. Do not power wash Ultrashield decking.

## **MOULD, MILDEW, ALGAE ETC:**

Mould and mildew can appear on the deck surface due to decaying organic materials such as wood, leaf and pollen, along with elevated temperatures, air and water. Therefore, it is important to remove these materials as quickly as possible. Clean mould and mildew with warm soapy water. For decks with mould, use AlgoClear to clean and minimise growth. The occurrence of mould can be reduced by installing your decking with the required fall, as standing water will remain on the deck surface for a longer period of time than normal.

## **WE RECOMMEND TO CLEAN YOUR DECK WITH ALGOCLEAR®:**

AlgoClear® is a concentrated cleaner used for soft-washing that removes discolourations and organic matter on hard surfaces. Ideal for algae, lichen, mould and biofilm on paving, patios, render, tarmac, artificial grass and sports surfaces. Does not contain bleach or ammonia.



Use a sprayer to apply.

Mix water 10:1 with AlgoClear and spray on area until it has a wet look. For full instructions on using AlgoClear, please visit our website.

## **TANNINS / STAINS:**

Remove debris within the gaps of the deck to reduce the chances of tannins

forming. Tannins can form when organic material gets stuck within the gaps of the deck and water starts to pool under it.

## **OIL, GREASE OR FOOD:**

Promptly remove all oil, grease, and food spills. Use warm soapy water and a soft non-metal scrub brush to clean. For stubborn stains, use an all-purpose cleaner. Check with the manufacturer to determine which cleaners are appropriate for use on your deck.

## **PROTECTION:**

Use a mat under your BBQ to protect from grease stains and plastic protectors under metal furniture or planters to prevent gouging and rust stains.

## **WATER MARKING:**

Some water marking may occur on the surface of the Portland Collection after installation. Clean with a bristle deck brush and hot water to remove it.

## **WEATHERING:**

Composite Decking may experience Extractive Bleeding, which can cause temporary discoloration of the deck. This will weather away in 10-12 weeks.

## **SNOW AND ICE:**

Whiteriver decks can become slippery in winter weather. Use calcium chloride or rock salt to melt snow and ice, but be careful of build-up leaving a white residue that can be removed with warm soapy water and a soft non-metal scrub brush.

## **SCRATCHES AND HEAVIER STAINS:**

Use a wire brush or sanding with 80-100 grit sandpaper to remove scratches or difficult stains on the Portland Range. Repair time takes 8-10 weeks to blend back in with the rest of the deck. Do not sand Ultrashield Decking.

## **MASONRY CONSTRUCTION:**

Cover the deck with a sheet of tarpaulin or construction grade plastic film during masonry construction,

renovation, or painting to prevent mineral deposits from leaving a white or hazy residue on the deck surface. Ensure that masonry/cement construction is set properly before installing the decking material.

## **IRREGULAR HEAT SOURCES / FIRE:**

Take extra caution with irregular heat sources such as fire pits, fireplaces, and barbecue grills, as composite decking has the tendency to retain heat, which may damage the deck surface.

## **STATIC:**

Reduce static electricity on the deck with Heavy Duty Staticide, a non-toxic clear treatment residual substance.



**Whiteriver**

composite for living

### Follow Us

Join our social media community for tips and discover new products.

 [www.instagram.com/whiteriver\\_group](https://www.instagram.com/whiteriver_group)

 [www.linkedin.com/company/whiteriver-group](https://www.linkedin.com/company/whiteriver-group)



05/23

[www.wrg.ie](http://www.wrg.ie)

### Architects & Designers

Request our decking samples to hold the premium quality of a Whiteriver product in your hands to truly get a sense of the real colours and surfaces. Please feel free to get in touch and we would be delighted to help you with your project.

[enquiries@wrg.ie](mailto:enquiries@wrg.ie) / +353 (0) 41 686 1000



**Keep me, or recycle me**